

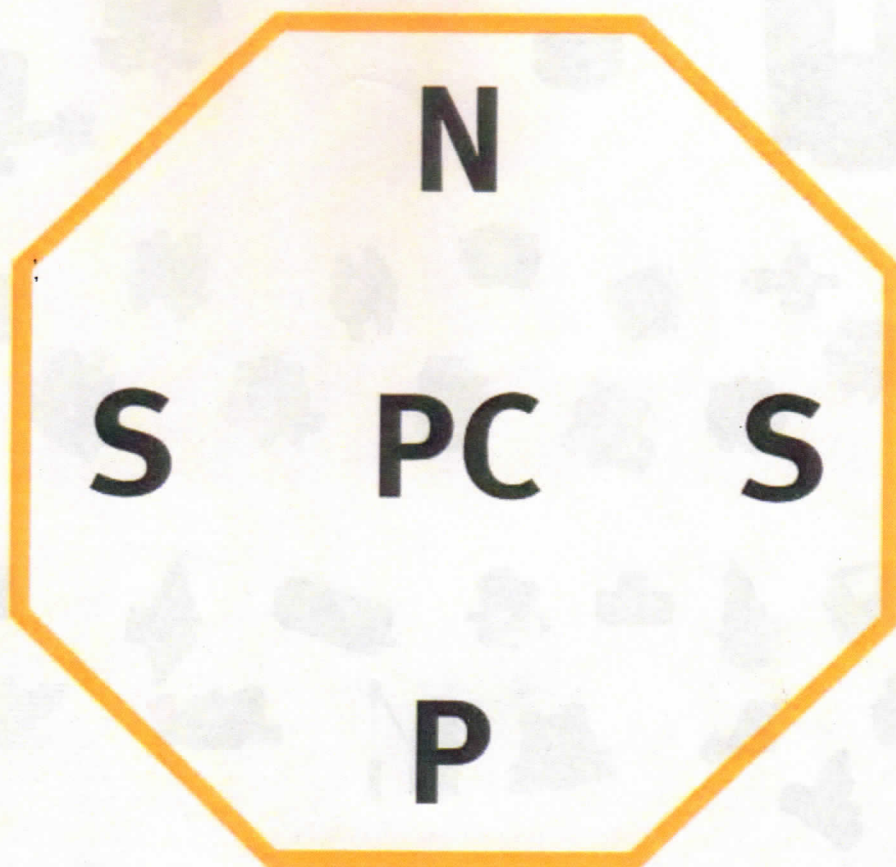

NEW SPARE PARTS SYSTEMS PC
ΣΥΣΤΗΜΑΤΑ ΠΕΔΗΣΕΩΣ
WEB SITE www.pcnsps.gr

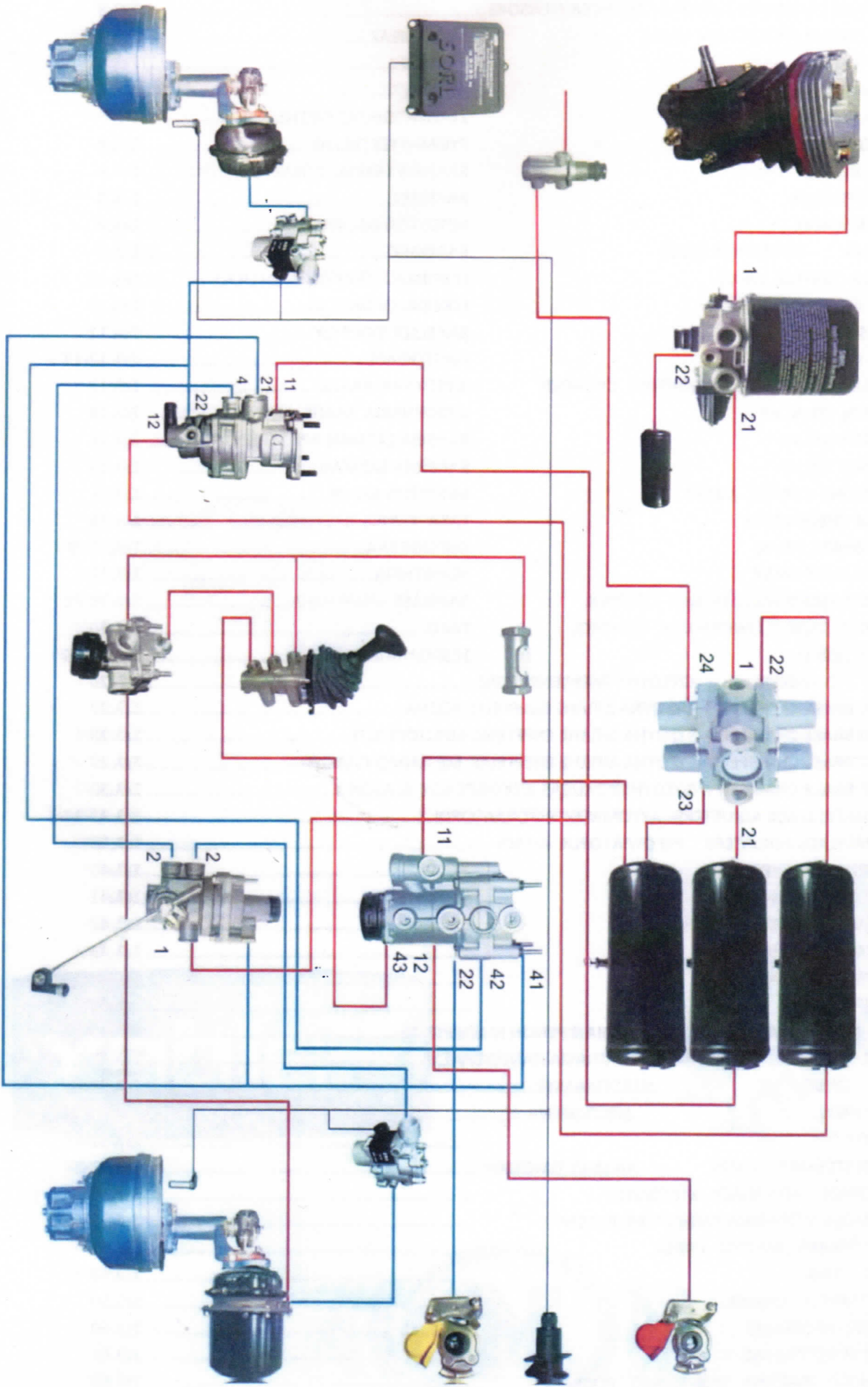







1	AIR DRYER	ΑΠΟΞΗΡΑΝΤΗΡΕΣ.....	Σελ. 1-2
2	AIR DRYER CARTRIDGE / HEATER / SILENCER /SENSORS.....		Σελ. 3
3	FOUR CIRCUIT PROTECTION VALVE	ΔΙΑΝΟΜΕΑΣ.....	Σελ. 4-5
4	RELAY VALVE	ΡΕΛΕΔΕΣ.....	Σελ. 6
5	UNLOADER VALVE	ΣΚΑΣΤΡΕΣ.....	Σελ. 7
6	PRESSURE LIMITING VALVE	ΣΤΑΘΕΡΠΟΙΗΤΕΣ ΠΙΕΣΗΣ.....	Σελ. 7
7	CHARGING VALVE (OVERFLOW)	ΡΥΘΜΗΣΤΕΣ ΠΙΕΣΗΣ.....	Σελ. 8
8	QUICK RELEASE VALVE	ΒΑΛΒΙΔΑ ΤΑΧΕΙΑΣ ΑΠΕΛΕΥΘΕΡΩΣΗΣ.....	Σελ. 8
9	SHUT OFF COCK	ΒΑΛΒΙΔΕΣ.....	Σελ. 9
10	RELEASE VALVE	ΜΠΟΥΤΟΝ ΔΑΛΙΚΑΣ.....	Σελ. 9
11	PARKING GOVERNOR VALVE	ΒΑΛΒΙΔΕΣ.....	Σελ. 9
12	TRAILER CONTROL VALVE	ΕΓΚΕΦΑΛΟΙ ΤΡΑΚΤΟΡΑ- ΔΑΛΙΚΑΣ.....	Σελ. 10
13	RELAY EMERGENCY VALVE	ΕΓΚΕΦΑΛΟΙ ΔΑΛΙΚΑΣ.....	Σελ. 10
14	LOAD SESING VALVE	ΒΑΛΒΙΔΕΣ ΦΟΡΤΙΟΥ.....	Σελ. 11
15	FOOT VALVE	ΠΑΝΤΟΦΛΕΣ.....	Σελ. 12-13
16	DOUBLE ACTING CYLINDER CONTROL CYLINDER	ΦΥΣΟΥΝΑΚΙ ΚΛΑΠΕ.....	Σελ. 13
17	CONTROL CYLINDER	ΦΥΣΟΥΝΑΚΙΑ ΚΛΑΠΕ- ΓΚΑΖΙΟΥ.....	Σελ. 14
18	GEARBOX VALVE	ΒΑΛΒΙΔΑ ΣΑΣΜΑΝ ΑΡΓΟ ΓΡΗΓΟΡΟ.....	Σελ. 14
19	GEARBOX VALVE	ΒΑΛΒΙΔΕΣ ΣΑΣΜΑΝ.....	Σελ. 15
20	DIRECTIONS CONTROL VALVE	ΜΠΟΥΤΟΝ ΚΛΑΠΕ.....	Σελ. 15
21	DOYBLE CHECK VALVE	ΤΑΚΑ -ΤΑΚΑ.....	Σελ. 16
22	HAND BRAKE VALVE	ΧΕΙΡΟΦΡΕΝΑ.....	Σελ. 17-19
23	ROTARY SLIDE VALVE	ΧΕΙΡΙΣΤΗΡΙΑ.....	Σελ. 19
24	ECAS SOLENOID VALVE HEIGHT CONTROL	ΒΑΛΒΙΔΕΣ ΑΝΑΡΤΗΣΗΣ.....	Σελ. 20-22
25	SOLENOID RAISE / LOWER VALVE CONTROL	ΤΑΚΟΙ.....	Σελ. 20
26	CLUTCH SERVO	ΣΕΒΡΟΑΜΠΡΑΓΙΑΣ.....	Σελ. 23-25
27	BRAKE CHAMBER ΦΥΣΟΥΝΑ ΜΟΝ.ΕΝΕΡΓΕΙΑΣ.....		Σελ. 26
28	SPRING BRAKE CHAMPER ΦΥΣΟΥΝΑ ΔΙΠΛΗΣ ΕΝΕΡΓΕΙΑΣ ΑΞΟΝΑ.....		Σελ. 27
29	SPRING BRAKE CHAMPER ΦΥΣΟΥΝΑ ΔΙΠΛΗΣ ΕΝΕΡΓΕΙΑΣ ΔΙΣΚΟΦΡΕΝΟΥ.....		Σελ. 28
30	SPRING BRAKE CHAMPER ΦΥΣΟΥΝΑ ΔΙΠΛΗΣ ΕΝΕΡΓΕΙΑΣ ΜΕ ΛΑΙΜΟ-ΠΛΑΚΑΚΙ.....		Σελ. 29
31	SPRING BRAKE CHAMPER ΦΥΣΟΥΝΕΣ ΔΑΛΙΚΑΣ ΔΙΣΚΟΦΡΕΝΟΥ & ΑΞΟΝ.....		Σελ. 30
32	AUTOMATIC SLACK ADJUSTERS ΑΥΤΟΜΑΤΟΙ ΡΕΓΟΥΛΑΤΟΡΟΙ.....		Σελ. 31-39
33	MANUALSLACK ADJUSTERS ΡΕΓΟΥΛΑΤΟΡΟΙ ΑΠΛΟΙ.....		Σελ. 39
34	CONTROL ARM TYPE		Σελ. 40
35	PALM COUPLING	ΧΟΥΦΤΕΣ.....	Σελ. 41
36	ΚΟΦΤΗΣ - ΦΙΛΤΡΟ - ΣΠΙΡΑΛ		Σελ. 42
37	ΜΠΟΥΛΟΝΙΑ ΠΑΞΙΜΑΔΙΑ		Σελ. 43
38	ΜΠΟΥΛΟΝΙΑ ΤΡΟΧΟΥ		Σελ. 44
39	ΕΛΑΤΗΡΙΑ		Σελ. 45
40	BRAKE MASTER CYLINDER ΑΝΤΛΙΑ ΦΡΕΝΩΝ Μ.ΕΝΕΡΓΕΙΑΣ.....		Σελ. 46
41	WHEEL CYLINDER ΚΥΛΙΝΔΡΑΚΙΑ- ΤΡΟΜΠΑΚΙΑ ΠΑΝΤΟΦΛΑΣ.....		Σελ. 47
42	BRAKE DISCS ΔΙΣΚΟΠΑΛΑΚΕΣ.....		Σελ. 48
43	BRAKE PADS ΔΙΣΚΟΦΡΕΝΑ.....		Σελ. 49-50
44	ΘΕΡΜΟΥΙΤ		Σελ. 51-52
45	POWER STEERING PUMPS ΑΝΤΛΙΕΣ ΤΙΜΟΝΙΟΥ.....		Σελ. 53-54
56	ΣΥΝΔΕΣΜΟΙ & ΚΟΡ ΑΠΛΟΙ - ΣΥΣΤΟΛΙΚΟΙ		Σελ. 55
57	ΠΑΞΙΜΑΔΙΑ-ΜΠΙΜΠΙΚΙΑ-ΑΝΤΙΣΤΑΣΕΙΣ-ΚΥΑΘΙΑ		Σελ. 56
58	ΡΑΚΟΡ ΠΙΝΑΚΑ - ΜΑΣΤΟΙ - ΟΥΡΕΣ		Σελ. 57
59	ΓΩΝΙΕΣ - ΤΑΦ		Σελ. 58
60	ΤΑΦ - ΣΤΑΥΡΟΙ - ΘΗΛΙΕΣ		Σελ. 59
61	ΜΟΥΦΕΣ -ΛΑΔΟΒΙΔΕΣ		Σελ. 60
62	ΡΑΚΟΡ ΧΕΙΡΟΠΡΕΣΣΑΣ		Σελ. 61
63	ΑΥΤΟΜΑΤΑ ΠΛΑΣΤΙΚΑ ΤΑΦ- ΓΩΝΙΕΣ - ΡΟΔΕΛΕΣ		Σελ. 62
64	ΣΥΝΔΕΣΜΟΙ ΑΥΤΟΜΑΤΟΙ		Σελ. 63
65	ΤΑΦ- ΓΩΝΙΕΣ- ΚΟΡ ΑΥΤΟΜΑΤΑ		Σελ. 64
66	ΣΩΛΗΝΕΣ		Σελ. 65-66

EIKONA	ΚΩΔΙΚΟΣ	ΕΦΑΡΜΟΓΗ	ΠΕΡΙΓΡΑΦΗ
	3511 003 036 0	DAF 1505972	TYPE WABCO 8,1 Bar
	RL355AZ	MAN 88521026007	ΧΩΡΙΣ ΣΚΑΣΤΡΑ
	432 420 000 0	Neoplan 11017448	Ports:1+21M22X1,5, 22+4M12X1,5
		IVECO 42530780	Heat:24V,Conn...:M27X1
	Kit 432 410 002 2 3511 003 012 9	M/S 0004316715	CUT-Off Pressure: 8,1 Bar
	3511 005 006 0	DAF: 1518680	TYPE KNORR 8,1 Bar
	RL3511CH-A	MAN 81521026019	Ports:1+21=M22X1,5, 22+4=M12X1,5
	LA6200 -1	NEOPLAN 110273630	Heat:24V,:M27X1
	Kit I87917- 3511 005 005 9		CUT-Off Pressure:8,1 Bar
	3511 003 026 0	Mercedes	TYPE WABCO 8.1
	RL3511AM-A FA30003C	MAN	ΣΚΑΣΤΡΑ+ΗΛΕΚΤΡΙΚΟ
	432 410 104 0 (1020)	EVOBUS	Ports1+21=M22X1,5,2+4=M12X1,5
	FA3003B	IVECO	Heat:24V,:M27X1 Voss
	FA3003A	MAN 81521026098	TYPE WABCO 10 BAR
			Ports:1+21 M22X1,5 22+4 M12X1,5
			Heat:24V,:M27X1 VOSS
	Kit 432410002 2- 3511 003 012 9 - RL3511AM-9		CUT-Off Pressure:10 Bar
	33511 003 098 0	MAN 81521026098	TYPE WABCO 10 BAR
	RL3511AM0 (LA8206)	DAF1517969	Port 1, 21:M22x1,5 22M16X1.5 Voss
	432 410 117 0		(Χωρίς ηλεκτρικό)
			CUT-Off Pressure:10 Bar
	3511 003 130 0	MAN 81521026103	TYPE-WABCO 10 BAR
	RL3511AM10	DAF 1518678	Port 1,21 M22X1,5 Voss
	432 410 116 0		Heat:24V,:M27X1Port 22:6X1,5 Voss-
			CUT-Off Pressure:10 Bar Bayonet
	3511 003 099 0		TYPE-WABCO 8,5 BAR
	RL3511AM04	DAF 1517968	Port 1,21M22X1,5, Voss
	432 410 115 0	MAN 81521026119	Port22:16X1,5 Voss
	Kit 432 410 002 2 3511 003 012 9 RL3511AM-9		CUT-Off Pressure:8,5 Bar (Χωρίς ηλεκτρικό)
	3511 003 097 0	MAN 81521026097	TYPE WABCO 12,5 BAR
	RL3511AM02	DAF 1517967	Port 1,21M22X1,5 Voss
	432 410 113 0		Port22:16X1,5 Voss
	Kit 432 410 002 2 3511 003 012 9 RL3511AM-9		CUT-Off Pressure:12,5Bar(Χωρ. ηλεκ)
	3511 003 156 0	DAF 1518674	TYPE WABCO 12,5 BAR
	RL3511AM26	M/S	Port 1,21M22X1,5 Voss
	432 410 034 0	IVECO 08160471	Port22:12X1,5 Port 4, 23:M12x1,5
	FA3003C	VOLVO	Heat:24V,:8942600492
	3511 003 155 0	Neoplan 110275100	TYPE WABCO 9,5BAR
	RL3511AM25		Port :1,21M22X1,5 22:M12x1,5
	432 410 020 0		Heat:24V,Conn:M27X1
	KitS 432 410 002 2 3511 003 012 9 RL3511AM-9		CUT-Off Pressure:9,5 Kostal





EIKONA	ΚΩΔΙΚΟΣ	ΕΦΑΡΜΟΓΗ
	3511 003 184 0	Scania 1441751
	RL3511 AM 01-A AM3511AM330)	
	432 410 081 0 (083)	
	Kit 432 410 002 2 3511 003 012 9 RL3511AM-9	
		TYPE WABCO 9,4 BAR Port 1+21: M22X1,5 Port 4+22:M12X1,5 PORT:4=M12X1,5 CUT-Off Pressure:9,4 Bar,Heat:24 V
	35110210010	VOLVO 204665229
	RL3511ED01	KINEZOS 20700794
	432 4251010	DAF 0882965
		Scania 1932701
		TYPE WABCO 13 BAR E C A D Port 1+2:M22X1,5 Port 4,23:M12X1,5 instal hole thread3xM12X1.5-6H DC24V
		VOLVO 3962679
	RL3511HD01	
	78990	
		TYPE HALDEX 12 BAR Ports1,21:M12X1,5 Cut-out Pressure:12,0 Bar
	3511 009 001 0	VOLVO 1082030
	RL3511FA	
	432 431 191 0	
	KIT RL3511FA-9- 432 431 022	
		TYPE WABCO 12 BAR Ports:1+21M22x1,5Port:4M16x1,5 Comment:Orifice Bore 0,9mm
	3511 006 003 0	M/S Ateco
	RL3511DH-A	0004301515
	932 400 003 0 (LA9000)	DAF 1505119
		TYPE WABCO 10 BAR Ports11,21M22X1,5 Ports22 M16X1,5
		M/S Actros
	RL3511XB03	A002431215
	932 400 024 0 (LA9010)	MAN-IVECO-DAF
		TYPE WABCO 12,3 ± 0,3 BAR Ports11,21M22X1,5 Ports12 M12.5 Ports21M22X1.5 Ports22 M16X1,5 VOSS24 M22X1,5 Ports VOSS
	932 500 035 0-1	
		TYPE WABCO 8,5 Bar με Διανομέα 5 Παροχών Port:1 M22x1,5 Port:21,22,23,24 M16x1,5
	ZB4578-KOOO394	DAF 1443153
	(LA8130+ AE4528)	IVECO41211254
	RL3511XB04	41211384
	ZB4587(LA8125 AE4502)	41.285.078
		TYPE KNOR 10 Bar TYPE KNOR 10,5 Bar Port 12,24m22x1.5 Port 23 M16X1,5
		M/S 0024310715
	9325001100	ATEGO- ACTROS
		DAF 1518170
		TYPE KNOR Bar Port 12,24m22x1.5 Port 23 M16X1,5
	3513 001 0030	
	RL3511KA	
	432 10 0202 2	
	432410 227 0 ΛΕΥΚ	
		ΦΙΛΤΡΟ ΞΗΡΑΝΤΗΡΑ 13 BAR M39X1,5
	3513 001 004 0	
	RL3511HA	
	432 410 226 2	
		ΦΙΛΤΡΟ ΜΕ ΠΑΞΙΜΑΔΙ SCANIA M 1 1/4"







ΕΙΚΟΝΑ	ΚΩΔΙΚΟΣ	ΕΦΑΡΜΟΓΗ	ΠΕΡΙΓΡΑΦΗ
	3513 500 001 0	MAN	AIR DRAYER CATRIDGE TYPE
		IVECO	HALDEX
	78964/92528/93522	DAF	
	RL3513EF01	VOLVO	
	4321990300		ΑΝΤΙΠΑΓΩΤΙΚΗ ΒΑΛΒΙΔΑ CAPACITY 200CM ANTI FREEZE PUMP
	3511 003 0058	MAN	ΣΙΓΑΣΤΗΡΑΣ 11 BAR
	RL3511AD020	IVECO	DIAM 69MM
	432 407 0700	DAF	ΚΟΥΜΠΟΤΟ
	3511 007 0238	M/S	ΣΙΓΑΣΤΗΡΑΣ 13 BAR
	RL3511EG23	IVECO	DIAM 87MM
	432 407 0120		
	RL3754AA01	M/S	ΣΙΓΑΣΤΗΡΑΣ 13 BAR
	432 407 0600		DIAM 68MM Port 22x1.5
	3511 012 003 0		ΣΕΤ ΗΛΕΚΤΡΙΚΟΥ ΞΗΡΑΝΤΗΡΑ
	894 260 040 2		ΤΥΠΟΥ Wabco
	K2422		24Volt-100Watt- M27X1-2 Pin.+7 To 29 Celsius
	3511 017 007 0		ΣΕΤ ΗΛΕΚΤΡΙΚΟΥ ΞΗΡΑΝΤΗΡΑ
	894 260 043 2		ΤΥΠΟΥ Wabco
	K2442		Volvo 24Volt-100Watt
	3511 012 005 0		ΣΕΤ ΗΛΕΚΤΡΙΚΟΥ ΞΗΡΑΝΤΗΡΑ
	K2432		ΤΥΠΟΥ Wabco
	894 260 049 2		24Volt-100Watt Bayonet+7To29 Celcius
	351101201310		ΣΕΤ ΗΛΕΚΤΡΙΚΟΥ ΞΗΡΑΝΤΗΡΑ
	K2472		ΜΕ ΣΠΕΙΡΩΜΑ
			M27X1 KNORR 24Volt-100Watt
	KX013		ΚΑΛΩΔΙΟ ΡΕΥΜΑΤΟΣ
	3550 3308080		SENSOR ABS ΙΣΙΟΣ
	441 032 9632		400MM
	3530 330 8090		SENSOR ABS ΙΣΙΟΣ . 1 M
	3550 301 8080		ΑΣΘΗΤΗΡΑΣ ΓΩΝΙΑ
	441 032 808 0		400MM
	3550 301 8090		ΑΣΘΗΤΗΡΑΣ ΓΩΝΙΑ

ΕΙΚΟΝΑ	ΚΩΔΙΚΟΣ	ΕΦΑΡΜΟΓΗ	ΠΕΡΙΓΡΑΦΗ
	3515 006 005 0	IVECO 42078368	ΔΙΑΝΟΜΕΑΣ 5 ΠΑΡΟΧΩΝ
	RL3515KE	DAF 670766	ΤΥΠΟΥ WABCO
	AE4170 314039001	M/S 0014310106	Ports 21,22,23,24 M16X1,5 1M22X1,5
	934 702 250 0	.0014316806	Opening Pressure 21,22,23,24 7.0 BAR
	kit RL3515DA-9 9349010052 3515 00333 004 0-9		
	3515 007 031 0	IVECO 42078368	ΔΙΑΝΟΜΕΑΣ 5 ΠΑΡΟΧΩΝ
	RL3515LF06	DAF 670766	ΤΥΠΟΥ KNORR
	AE4170 AE4158	M/S 0014310106	Ports 21,22,23,24 M16X1,5 1M22X1,5
	934 702 250 0	.0014316806	Opening Press. 21,8.0 22,23,24,6,7BAR
	3515 017 0010	M/S 0024317306	ΔΙΑΝΟΜΕΑΣ 5 ΠΑΡΟΧΩΝ
	RL3515WA01	DAF 1518181	ΤΥΠΟΥ WABCO
	AE4402		Ports 1,21,22,23,24 M22X1,5 VOSS
	934 702 260 0		Opening Pressure 7.0 BAR
	3515 008 0010 RL3515MA	DAF 1524857	ΔΙΑΝΟΜΕΑΣ 5 ΠΑΡΟΧΩΝ
	AE4422	IVECO 5801102059	ΤΥΠΟΥ WABCO
	934 714 010 0	MAN 81521516082	Ports: 1, M22X1,5 21,22,23,24 M16X1,5
	Repair kits RL3515MA-9	81521516082	Opening Pressure 21,22,23,24 5,9 BAR
	3515 007 029 0 3515 003 0020	MAN 81521516007	ΔΙΑΝΟΜΕΑΣ 5 ΠΑΡΟΧΩΝ
	3515 003 0120 (9347020410)	M/S 0014313006	ΤΥΠΟΥ WABCO (2 ΑΝΩ 2ΚΑΤΩ)
	AE4158 314018001	002 431 06 06	Ports: 1, M22X1,5 21,22,23,24 M16X1,5
	kit RL3515EA-A-9 9347020042		
	3515 002 001 0	DAF 1518178	ΔΙΑΝΟΜΕΑΣ 7 ΠΑΡΟΧΩΝ
	RL3515DA	MAN 81521516020	ΤΥΠΟΥ WABCO
	AE4162	M/S 0014313506	Ports 21,22,23,24 M16X1,5 1M22X1,5
	934 702 210 0	.0014319806	Opening Pressure 21,22,23,24 7.0 BAR
	kit RL3515DA-9 9349010052		
	3515 001 001 0	DAF 1518178	ΔΙΑΝΟΜΕΑΣ 7 ΠΑΡΟΧΩΝ
	RL3515CA	MAN 81521516020	ΤΥΠΟΥ KNORR
	AE 4162	M/S 0014313506	Ports 21,22,23,24 M16X1,5 1M22X1,5
	934 702 210 0	14319806	Opening Pressure 7.0 BAR
	kit RL3515CA-9 I81171		
	3515 011 013 0	DAF 1505128	ΔΙΑΝΟΜΕΑΣ 6 ΠΑΡ. ΤΥΠΟΥ WABCO
	RL3515SA01	MAN ZG046430002	Port:1flange main feeds M22X1,5VOSS
	AE4510 FA3011B	M/S 0034315406	Open1+2 9.0 bar Open3+4 7.5 bar
	934 705 005 0	KOGEL 341420	Close1+2 7.0 bar Close 3+4 7.5 bar
	3515 023 003 0	IVECO 042535024	ΔΙΑΝΟΜΕΑΣ 5 ΠΑΡ. ΤΥΠΟΥ KNORR
	RL3515AH03		Ports: 1, 22,23,24 M16X1,5 26 M22X1,5
	AE4502		VOSS DC 5V
	NWBAE4502		
	3515 018 012 0	ECS, ECT, ECX	ΔΙΑΝΟΜΕΑΣ 5 ΠΑΡΟΧΩΝ
	RL3515XA12	MAN F 2000/Bus	ΗΜΙΠΛΑΣΤΙΚΟΣ ΤΥΠΟΥ KNORR
	AE4613	81521516093	Ports: 1, M22X1,5 21,22,23,24 M16X1,5
			Opening Pr.21,22,24 690kPa 23.700kPa
	3515 018 0070	M/S ATEGO	ΔΙΑΝΟΜΕΑΣ 5 ΠΑΡΟΧΩΝ
	RL3515XA07	EVOBUS AXOR	ΗΜΙΠΛΑΣΤΙΚΟΣ ΤΥΠΟΥ KNORR
	AE4615		Ports 21,22,23,24 M16X1,5 1M22X1,5
			Opening Pre 23,24 770-800 21/22 KP
			6.3BAR





ΕΙΚΟΝΑ	ΚΩΔΙΚΟΣ	ΕΦΑΡΜΟΓΗ	ΠΕΡΙΓΡΑΦΗ
	3515 018 0030 (RL3515XA03)	MAN	ΔΙΑΝΟΜΕΑΣ 5 ΠΑΡΟΧΩΝ
	AE4609		ΗΜΙΠΛΑΣΤΙΚΟΣ ΤΥΠΟΥ KNORR Ports: 1, 21,22,23,24 M16X1,5 VOSS
	3515 018 001 0 (RL3515XA01)	VOLVO	ΔΙΑΝΟΜΕΑΣ 7 ΠΑΡΟΧΩΝ
	AE4604		ΗΜΙΠΛΑΣΤΙΚΟΣ ΤΥΠΟΥ KNORR
	3515 025 001 0 (RL3515XC01) 934 714 740 0		ΗΜΙΠΛΑΣΤΙΚΟΣ ΤΥΠΟΥ WABCO Ports: 1M22X1.5 21,22,23,24 M16X1,5

RELAY VALVE 7 ΠΑΡΟΧΩΝ

ΕΙΚΟΝΑ	ΚΩΔΙΚΟΣ	ΕΦΑΡΜΟΓΗ	ΠΕΡΙΓΡΑΦΗ
	3518 001 009 0	M/S- MAN814360	ΡΕΛΕ
	973 001 010 0	IVECO 1278511	Ports: 1,2,4 M22X1,5
	3518 001 013 0	IVECO 04464164	ΡΕΛΕ 22X1,5
	RL3518AK	MAN 81521166010	Ports: 1M22X1,5 2,4 M16X1,5
	973 001 020 0 Kit RL3518AH-9 35180010090-9	M/S 0004293044	
	3518 019 010 0		ΡΕΛΕ ΚΟΝΤΟΣ ΜΕ ΣΙΓΑΣΤΗΡΑ
	RL3518ZH		Ports: 1,2M22X1,5 4 M16X1,5
	9730110040		VOSS
	3518 019 003 0 RL3518ZB-A	SCANIA 1322986	ΡΕΛΕ ΚΟΝΤΟΣ ΠΑΡΟΧΕΣ
	FA4001B – FA4001C	DAF 1519331	Ports: 1,2M22X1,5 4 M16X1,5
	973 011 001 0	VOLVO 1082666	VOSS
	Kit RL3518ZA-9	MAN 4047273	
	3518 019 004 0	SCANIA 1425183	ΡΕΛΕ ΚΟΝΤΟΣ
	RL3518ZF		Ports: 1,2=1/2 NPT 4=1/4
	9730110050		
	3518 009 024 0	M/S - DAF	ΡΕΛΕ ΔΙΠΛΟΣ
	RL3518KH		All Ports M22X1,5
	473 017 007 0		
	3518 019 008 0	IVECO 41025604	ΡΕΛΕ
	RL3518ZE-A		Ports: 1,2M22X1,5 41, 42 M16X1,5
	973 011 203 0 Kit RL3518ZE-A-9		
	3518 019 006 0	DAF 1302103	ΡΕΛΕ ΜΕ VOSS ΠΑΡΟΧΕΣ
	RL3518ZE	IVECO 5010207451	ΧΩΡΙΣ ΣΙΓΑΣΤΗΡΑ
	973 011 205 0	M/S 0054291044	Ports: 1,2 M22X1,5 41, 42 M16X1,5
	Kit RL3518ZE-9	RVI 5010207451	
	3518 005 006 0	DAF 10898549	ΡΕΛΕ
	RL3518EA2	LEYLAND CAL0992	Ports:sup=1/2 PT Del=38/ PT Contin=1/4 pt
	OE 280375	RENAULT 26907700	
		VOLVO 353298	
	35270010020	TRAILER	ΡΕΛΕ
	RL3527AB		DALICA ΕΓΓΛΕΖΙΚΗ
	281860		Ports:sup=3/4 npt res=38/ npt

EIKONA	ΚΩΔΙΚΟΣ	ΕΦΑΡΜΟΓΗ	ΠΕΡΙΓΡΑΦΗ
	35502100180	DAF 1504901	ΡΕΛΕ
	RL3550FA	IVECO 41027224	ABS ΑΥΤΟΚΙΝΗΤΟΥ
	4721950180	SCANIA 1376793	Ports: 1,2 M22X1,5 DC 24V
			VOLVO 1079666
	35502100180	DAF 1504901	ΡΕΛΕ
	35502100240	DAF1304635	ΡΕΛΕ
	RL3550SM24	MAN 4082200	ABS ΑΥΤΟΚΙΝΗΤΟΥ
	4721950160	M/S 0044296544	Ports: 1,2 M22X1,5 VOSS DC 24V
	3518 020 003 0	DAF1624254	ΡΕΛΕΣ
	RL3518ZZ	MAN N2524526001	ΔΙΠΛΟΣ ABS
	4721950410	KRONE 5815328	Ports: 1,2 M22X1,5 4 M16X1,5
	RL3518ZZ-9		
	3518 020 001 0	SCHMITZ 050091	ΡΕΛΕ
	RL3518ZC	KRONE 5815453	ABS DALICAS
	4721950310	KOGEL349275	Ports: 1,2 M22X1,5 4 M16X1,5
	3518 0190 06 0	DAF 1519332	ΡΕΛΕ
	RL3518ZA01	MAN ZG046570002	
	973 011 201 0	KRONE 5818121	Ports: 1, M22X1,5 21,22,41,42M16X1,5
	3518 031 001 0		ΡΕΛΕ
	AC574BYW		Ports: 1,2 M22X1,5 4M16X1,5
	3518SK01		
	3518 042 001 0	DAF 1505150	ΡΕΛΕ
	RL 3518AE01 FA4019C	MAN 81521166067	ΠΛΑΣΤΙΚΟΣ
	973 006 001 0	M/S 0044290644	Ports: 1,21,22,23 M22X1,5 4M12X1,5
	3518 019 010 0- 973 011 004 0	DAF 1505150	ΡΕΛΕ ΜΕ ΣΙΓΑΣΤΗΡΑ



UNLOADER VALVE ΣΚΑΣΤΡΕΣ

EIKONA	ΚΩΔΙΚΟΣ	ΕΦΑΡΜΟΓΗ	ΠΕΡΙΓΡΑΦΗ
	3512 006 002 0	IVECO 2516892	ΣΚΑΣΤΡΑ ΤΥΠΟΥ WABCO
	RL3512AB		ΜΕ ΜΕΤΑΛΙΚΟ ΚΑΠΑΚΙ
	975 300 110 0	M/S 0014310006	ports:1+21=M22X1,5,1-2=M16X1,5
	kits:3512 006 102-9 RL3512AB-9 975 300 000 2		Cut-out pressure: 8.1 BAR
	3512 014 001 0	DAF 1505157	ΣΚΑΣΤΡΑ ΤΥΠΟΥ KNOR
	RL3512NA	IVECO 2516892	
	0481 039 221 000	M/S 0014310006	ports:1+21M22X1,5 1-2 M16X1,5
	975 300 110 0	MAN 81521016076	Cut-out pressure: 8.1 BAR
	3512 007 014 0	M/S 0014310006	ΣΚΑΣΤΡΑ ΤΥΠΟΥ WABCO
	RL3512BJ	IVECO 2516892	ΚΑΠΑΚΙ ΠΛΑΣ. ΧΩΡΙΣ ΥΠΟΔ. ΞΗΡΑΝΤΗΡΑ
	975 303 473 0		ports:1+21M22X1,5
	Kits:3512 007 007 0 RL3512BJ-9 975 303 001 2		Cut-out pressure: 8.1 BAR
	3512 007 015 0	M/S 0024311506	ΣΚΑΣΤΡΑ ΤΥΠΟΥ WABCO
	RL3512BK	DAF 285768	ΜΕ ΥΠΟΔΧΗ ΞΗΡΑΝΤΗΡΑ
	975 303 474 0		ports:1+21M22X1,5 22 M12X1,5
			Cut-out pressure: 8.1 BAR





ΕΙΚΟΝΑ	ΚΩΔΙΚΟΣ	ΕΦΑΡΜΟΓΗ	ΠΕΡΙΓΡΑΦΗ
	3531 013 036 0	DAF1236573	ΡΥΘΗΣΤΗΣ ΑΕΡΟΣ (ΠΥΡΓΑΚΙ)
	RL3531WA11	MAN 81521106101	Ports M22X1.5
	434 100 047 0	M/S 00442298144	Opening Press.(1000-1030)kPa
	3531 013 001 0	DAF 0633492	ΡΥΘΜΗΣΤΗΣ ΑΕΡΟΣ (ΠΥΡΓΑΚΙ)
	RL3531WA01	MAN 81521106101	Ports M220X1.5
	434 100 125 0	M/S 000427544	ΧΩΡΙΣ ΕΠΙΣΤΡΟΦΗ
		VOLVO 0052365395	Opening Press.6.0 Bar
	3531 013 002 0	DAF 011044	ΡΥΘΗΣΤΗΣ ΑΕΡΟΣ (ΠΥΡΓΑΚΙ)
	RL3531WA02	IVECO 025 16827	Ports M22X1.5
	434 100 024 0	M/S 000429554	Opening Press.6.0 Bar
	3531 013 003 0	VOLVO 1580313	ΡΥΘΗΣΤΗΣ ΑΕΡΟΣ (ΠΥΡΓΑΚΙ)
	RL3531WA11	IVECO 2516829	Ports M22X1.5
	434 100 221 0	M/S 0024296844	ΜΕ ΧΑΜΗΛΗ ΕΠΙΣΤΡΟΦΗ
			Opening Press.6.0 Bar
	3531 010 0040	M/S A0014315706	ΡΥΘΜΗΣΤΗΣ ΑΕΡΟΣ (ΑΧΛΑΔΙ)
	RL3531GD	MAN 8154016150	Ports M16X1.5
	0481 009 022		Pelivery Pressure 7.3±0,15 Bar
	3531 010 010 0	VOLVO	ΡΥΘΜΗΣΤΗΣ ΑΕΡΟΣ (ΑΧΛΑΔΙ)
	RL3531GA10		Ports1,2 M22X1.5
	0481 009 047 000		output pressure: (750±15)k pa
	3531 010 016 0	DAF 369518	ΡΥΘΜΗΣΤΗΣ ΑΕΡΟΣ (ΑΧΛΑΔΙ)
	RL3531GB16	M/S A0014316914	Ports M22X1.5
	0481 009 029		Pelivery Pressure 8.0±0.15 Bar
	3531 028 001 0	SCANIA 322924	ΡΥΘΜΗΣΤΗΣ ΑΕΡΟΣ
	RL3531VA01		Ports M22X1.5
	AC152DX		Pelivery Pressure 7.6 Bar
	3516 070 001 0	DAF 1519338	ΒΑΛΒΙΔΑ ΜΕΙΩΤΙΚΗ
	RL3516QA01	IVECO 0247 2794	3 ΠΑΡΟΧΕΣ
	975 001 001 0	MAN 84 52120 6008	Ports M22X1.5
		NEOPL110273210	

QUICK RELEASE VALVE ΒΑΛΒΙΔΑ ΤΑΧΕΙΑΣ ΑΠΕΛΕΥΘΕΡΩΣΗΣ

	ΚΩΔΙΚΟΣ	ΕΦΑΡΜΟΓΗ	ΠΕΡΙΓΡΑΦΗ
	3516 020 001 0	SCANIA 1788954	ΒΑΛΒΙΔΑ ΤΑΧΕΙΑΣ ΑΠΕ/ΣΗΣ
	RL3516XA01		7 ΠΑΡΟΧΕΣ
	973 500 051 0		Ports11,12,3 M22X1.5 2, M16X1.5
	3516 015 0020	DAF1518273	ΒΑΛΒΙΔΑ ΤΑΧΕΙΑΣ ΑΠΕ/ΣΗΣ
		M/S 0044292544	4 ΠΑΡΟΧΕΣ
	RL3516TB		Ports1,11,23 M220X1.5
	3516 005 002 0	SCANIA 1339907	ΒΑΛΒΙΔΑ ΤΑΧΕΙΑΣ ΑΠΕ/ΣΗΣ
	RL3516ED	IVECO 1299031	Ports1 ,11,2,3 M22X1.5
	973 500 000 0		Ports 2, M16X1.5 3 M22X1.5

ΕΙΚΟΝΑ	ΚΩΔΙΚΟΣ	ΕΦΑΡΜΟΓΗ	ΠΕΡΙΓΡΑΦΗ
	3520 002 001 0	SCANIA	ΣΚΑΛΙΕΡΑ ΒΑΛΒΙΔΑΣ DALICAS
	RL3520AB		
	4756040110		Ports:1,2 M22X1,5
	BR1105 352008002		
	3520 001 001 0	SCANIA 124978	ΚΟΦΤΗΣ ΑΕΡΟΣ
	RL3520AA	VOLVO 351565	Ports:M22X1,5
	4520021070	IVECO1121692	
	4520021320		



RELEASE VALVE ΜΠΟΥΤΟΝ DALIKAS

ΕΙΚΟΝΑ	ΚΩΔΙΚΟΣ	ΕΦΑΡΜΟΓΗ	ΠΕΡΙΓΡΑΦΗ
	3520 501 001 0	DAF 073614144	ΜΠΟΥΤΟΝ DALIKAS
	RL3520AC	EVOBUS3283706000	Ports:1M22X1,5 2Flange
	9630010010		
	AE4214 352001001		
	3520 501 002 0	DAF1325328	ΜΠΟΥΤΟΝ DALIKAS
	RL3520ZA	MAN 82523106008	Ports:M22X1,5 2Φ21.5
	963 001 0130	BRW 8.283.706.000	
	AE4214 352012001		Kits:RL3520ZA-9/9630060002
	3520 501 005 0	DAF 0867882	ΜΠΟΥΤΟΝ DALIKAS
	RL3520ZA05	HINO	Ports:All M16x1,5
	9630060030		
	3520 501 002 0	DAF 1325329	ΜΠΟΥΤΟΝ DALIKAS
	RL3520ZB	RVI5000809163	Ports:1M16X1,5 2Φ21.5
	9630010120 AE4215		
	Kit:RL3520ZB-9/9630060002		
	3520 501 003 0	RVI 5021170428	ΜΠΟΥΤΟΝ DALIKAS
	RL3520ZC	MAN 1065271	Ports: M16x1,5
	963 006 001 0	IVECO 8193547	
	AE4200 207002001		Kit:RL3520ZC-9/9630060002

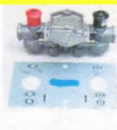
PARKING



ΕΙΚΟΝΑ	ΚΩΔΙΚΟΣ	ΕΦΑΡΜΟΓΗ	ΠΕΡΙΓΡΑΦΗ
	3520 504 002 0	DAF 1506448	PARKING
	RL3520ZD	NEOPLAN 07133000	Ports: M16x1,5
	963 001 051 0	KRONE 58124230	
		KOGEL 336490	
	3520 504 003 0	DAF	PARKING
	RL3520ZD03	SCANIA 1802800	Ports: M16x1,5
	963 001 050 0	RVI 5051170426	



GOVERNOR VALVE











ΕΙΚΟΝΑ	ΚΩΔΙΚΟΣ	ΕΦΑΡΜΟΓΗ	ΠΕΡΙΓΡΑΦΗ
	3512 002 001 0	VOLVO	ΚΗΒΕΡΝΗΤΗΣ
	RL3512GB		Ports:All M10X1
	1189393000		Cut-out pressure: 7,8 BAR
	Kit:RL3512GB-9		
	3512 002 028 0	VOLVO 272126	ΚΗΒΕΡΝΗΤΗΣ
	RL3512GL-M		Ports:All M10X1
	1189396000		Cut-out pressure: 12 BAR
	Kit:RL3512GL-M 9		

ΕΙΚΟΝΑ	ΚΩΔΙΚΟΣ	ΕΦΑΡΜΟΓΗ	ΠΕΡΙΓΡΑΦΗ
	3522 001 014	SCANIA 293139	ΕΓΚΕΦΑΛΟΣ ΤΡΑΚΤΟΡΑ
	RL3522AH	IVECO 2516806	ΤΥΠΟΥ WABCO
	9730024020		Ports All M16X1.5
	AB2761 355021001		
	Kits: 3522001001 9 RL3522AH 9730020042		
	3522 002 011 0	VOLVO 1607887	ΕΓΚΕΦΑΛΟΣ ΤΡΑΚΤΟΡΑ
	RL3522BJ-A	IVECO 04773986	ΤΥΠΟΥ WABCO
	9730025210		Ports All M16X1.5
	Kits: 35220020100-9 RL3522BJ-A-9 9730020052		
	3522 004 012 0	MAN 81523016183	ΕΓΚΕΦΑΛΟΣ ΤΡΑΚΤΟΡΑ
	RL3522FA01	81523016189	ΤΥΠΟΥ WABCO
	9730090060	KOGEL 6502113	Ports All M16X1.5
	3522 004 003 0	M/S 003411305	ΕΓΚΕΦΑΛΟΣ ΤΡΑΚΤΟΡΑ
	RL3522FB-A	KOGEL 332607	ΤΥΠΟΥ WABCO
	973 009 001 0		Ports 11, 12 22,41 42 M22X1.5 VOSS
	AB2823 355071001		Ports 43 M16X1.5 VOSS
	3522 004 001 0	DAF1259855	ΕΓΚΕΦΑΛΟΣ ΤΡΑΚΤΟΡΑ
	RL3522FA	MAN 82523016015	ΤΥΠΟΥ WABCO
	9730093000	RVI 50211704662	Ports 11, 12 22,41 42 M22X1.5 VOSS
		EVOBUS	Ports 43 M16X1.5
	3522 004 002 0	SCANIA 1350096	ΕΓΚΕΦΑΛΟΣ ΤΡΑΚΤΟΡΑ
	RL3522FB		ΤΥΠΟΥ WABCO
	973 009 010 0		Ports All M16X1.5
	3522 010 001 0	M/S 0004318213	ΕΓΚΕΦΑΛΟΣ ΤΡΑΚΤΟΡΑ
	RL3522YC01		ΤΥΠΟΥ KNORR
	AC596A		Ports 11, 12 22,41M22X1.5
			Ports 42 43 M16X1.5
	3522 009 003 0	DAF 0583512	ΕΓΚΕΦΑΛΟΣ ΤΡΑΚΤΟΡΑ
	RL3522YB03	M/S 0014312605	ΤΥΠΟΥ WABCO
	4712000080		Ports 1,2: 3XM22X1.5-6H
			Installation 4XM10

RELAY EMERGENCY VALVE ΕΓΚΕΦΑΛΟΙ DALICAS

ΕΙΚΟΝΑ	ΚΩΔΙΚΟΣ	ΕΦΑΡΜΟΓΗ	ΠΕΡΙΓΡΑΦΗ
		SCANIA 1328188	ΕΓΚΕΦΑΛΟΣ ΤΡΑΚΤΟΡΑ
		295120100	ΤΥΠΟΥ WABCO
	973 009 100 0		Ports 11, 12 22,41 42 M22X1.5 VOSS
			Ports 43 M16X1.5
			ΕΓΚΕΦΑΛΟΣ ΤΡΑΚΤΟΡΑ
	3527 004 002 0	DAF 1518259-1519302	ΒΑΛΒΙΔΑ DALICAS
	RL3527DB	MANN250509990164	Ports:All M22x1,5
	971 002 307 0	RVI 5021208564	
	Kits:3527 004 002 0-9/RL3527DB-9/9710020082		
	3527 004 001 0	DAF 1519300	ΒΑΛΒΙΔΑ DALICAS
	RL3527DA	MAN N250509990162	Ports:All M22x1,5
	971 002 304 0		
	Kits:3527 004 001 0-9/RL3527DA-9/9710020082		



ΕΙΚΟΝΑ	ΚΩΔΙΚΟΣ	ΕΦΑΡΜΟΓΗ	ΠΕΡΙΓΡΑΦΗ
	3527 004 004 0	DAF 1519310	ΒΑΛΒΙΔΑ DALICAS
	RL3527DD		Ports:Combination
	971 002 700 0		Of L3527DF+RL3520ZA
	Kit:3527 004 004 0-9/RL3527DD-9/9710020082		
	3527 003 004 0	DAF 1325333	ΒΑΛΒΙΔΑ DALICAS
	RL3518ND	NEOPLAN 07111000	Ports:Combination
	971 002 531 0		Of RL3518NB+RL3520ZB
	3527 003 004 0	DAF 1325333	ΒΑΛΒΙΔΑ DALICAS
	971 002 152 0	SCHMITZ M50024	ΒΑΛΒΙΔΑ DALICAS
			Port 1, 2 M 16x1.5
			Port 2: 4x M 16x1.5; 2x M 22x1.5
			Port 1-2: M 22x1.5
	3527 007 001 0	DAF1446687	ΒΑΛΒΙΔΑ ABS
	RL3527KA	MAN 2035185	ΔΙΠΛΗΣ ΕΝΕΡΓΕΙΑΣ ΤΥΠΟΥ HALDEX
	950364104		Ports:1,4 M16X1,5
	Kit:3527 003 002 0-9/RL3527KA-9/9710020032		
LOAD SESING VALVE			
	3523 001 023 0	M/S 0014318112	ΒΑΛΒΙΔΑ ΦΟΡΤΙΟΥ
	475 710 036 0		Port : 1,2 M22X1.5Voss; 4MX16 1.5 Voss
	3523 001 024 0	M/S 0014313312	
	475 710 020 0	DAF 1518121	Port : 1,2, 4M16X1.5
	3523 001 157 0	DAF1446687	ΒΑΛΒΙΔΑ ΦΟΡΤΙΟΥ
	475 710 136 0		Port : 1,2 M22X1.5Voss; 4MX16 1.5 Voss
	3523 002 008 0	M/S 6984313712	ΒΑΛΒΙΔΑ ΦΟΡΤΙΟΥ
	RL3523AK-C	KRONE 945013	Ratio1:8 Inshot 0,5
	4757145000	KOGEL351000,6502186	Empty P41,42:0.6 Empty P2 :1,4
	BR5522 602005001	76934	Laden P41,42:4,3
	3523 002 010 0	DAF1302096	ΒΑΛΒΙΔΑ ΦΟΡΤΙΟΥ
	RL3523AK-D	MAN N2521160021	Ratio1:8 Empty P41,42:0.5Empty P2 :1,4 6BAR
	4757111260		Laden P1,2,4:6BAR 41,42 0BAR P43M16X1.5
			Ports1,2,M22X1.5 41 42 M16X1.5 VOSS
	3523 002 009 0	RVI 5600528058	ΒΑΛΒΙΔΑ ΦΟΡΤΙΟΥ (ΕΞΑΓΩΝΟ)
	RL3523DA	MAN 1065242	Inshot 0,4
	4757004030	IVECO 8122061	Empty P41,42:0.6 Empty P2 :1,4
	BR5522 602005001	KRONE945015	Laden P41,42:4,3
	Kit:3523002009-9RL3523DA-9 4757000042		Ports1,2M22X1.5 41,42 M12X1.5
	3523 005 004 0	DAF 1506232	ΒΑΛΒΙΔΑ ΦΟΡΤΙΟΥ
	4757155000	SCHMITZ 8283011000	Ratio1:8 Inshot 0,5 cont :0.7
	Kit:35230050040-9 4757150002		Ports 1/4,1,2 M22X1.5 1M16X1.5
	3523 005 005 0		Ratio1:8 Inshot 0,5 cont :0.5
	4757150000		Ports 1/4,M16X1.5 1,2M22X1.5
	3523 002 007 0	DAF1518960	Ratio1:8 Inshot 0,6 cont p4:6.5
	4757110240	M/S0014319412	Ports1,2,M22X1.5 4,41 42 M16X1.5VOSS
	3523 005 001 0		
	475 712 0040		

EIKONA	ΚΩΔΙΚΟΣ	ΕΦΑΡΜΟΓΗ	ΠΕΡΙΓΡΑΦΗ
	3514 00 8004 0	IVECO 500317963	
	RL3514HE		Ports:M16x1,5
	DX75BA		Pred: 0,2 bar
	Kit:3514008004-9 RL3514HE-9 076620102000		
	3514 008 003 0	VOLVO 1628491	Ports:M12x1,5
	RL3514HD		Other Ports:M16x1,5
	MB4690		Pred: 0,3 bar
	3514 008 011 0	IVECO 99435645	All Ports:M16x1,5
	RL3514HE-B		Rratio:M16x1,5
	DX95B		Pred: 0,3 bar,DC:24V
	Kit: 35140080110-9 RL3514HE-B-9 076620102000		
	3514 019 004 0	MAN 81521306222	Intel Ports:11,12 M22X1,5-6H
	RL3514XA04		Ports:21,22 M22x1,5-6H
	MB4820		Control Ports:4 M16X1.5-6H
			Pred: 0,3 bar
	3514 019 001 0	MAN 81521306148	Intel Ports:11,12 M22X1,5VOSS
	RL3514XA01		Ports:21,22 M22x1,5-6VOSS
	MB4815,II36302		Control Ports:4 M16X1.5 Voss
			Pred: 0,3 bar
	3514 003 000 0	MAN 81523206030	Ports:M22x1,5
	RL3514CA		Other Ports:M16x1,5
	4613130500 MB4434		Ports:M22x1,5
	3514 008 011 0	DAF 1209116	Ports:M22x1,5 VOSS
	RL3514HC	1337184	Pred: 0,3 bar
	MB4694		
	3514 004 003 0	DAF1518067	Ports& del portsm16x1,5 4m12x1,5
	RL3514DD	M/S 0024310605	pred 0,4par, ratio 1,5:1
	4613190080 MB4650		
	Kit 35140040030 RL3514DD-9 4613190072		
	3514 004 025 0	DAF 1518060	
	RL3514DS	IVECO 04783981	All ports16x1,5
	4613150080 320023001	MAN 85500014354	pred 03 par
		MERCEDES 0014318	
	3514 004 078 0	DAF 1506089	ports11,12,21 22 4= m12x1,5
	RL3514DX-D		Other Ports:M12x1,5
	4613170000		pred 03 par Angle 35
			ports11,12,21 22 4= m12x1,5
	3154 013 000 0	DAF 1506089 1518064	All ports22x1,5 Voss
	RL3514EA	M/S 0034311505	pred 0,4 par
	4613152580		
	320049001 MB4647	Kit: RL3514EA-9	
	3514 013 001 0		
	461 315 248 0		

ΕΙΚΟΝΑ	ΚΩΔΙΚΟΣ	ΕΦΑΡΜΟΓΗ	ΠΕΡΙΓΡΑΦΗ
	3514 013 002 0	DAF 1518070	
	RL3514EB	M/S 0034311705	ports11,12,21,22=M22x1,5 Voss
	4613192710 MB4657		ports:4=M16X1.5 Voss
	RL3514EB-9		pred 0,4par, ratio 2:1
	3514 013 003 0	DAF 1518069	ports11,12,21,22=M22x1,5 Voss
	RL3514EB-A	M/S 0034316305	ports:4=M16X1.5 Voss
	4613192500 mb4661		pred 0,4par, ratio 1.25:1
	RL3514EB-A-9		
	3514 013 001 0	M/S 6954317405	All ports22x1,5 Voss
	RL3514EA04		pred 0,4 par
	4613152480		
	3514 013 006 0	DAF 1518069	ports11,12,21,22=M22x1,5 Voss
	RL3514EB-B	M/S 0034316305	ports:4=M16X1.5 Voss
	4613192600 MB4653		pred 0,4par, ratio 1.5:1
	3514 013 004 0	DAF 1518065	All ports2 Φ15±0.005
	4613152640	M/S 0044314605	pred 0,5par
	RL3514EC-9		
	3514 009 001 0	VOLVO1696150	All portsM22x1.5
	RL3514MB		pred 0,25par Fixed
	4613074790 MB4711		
	Kit 3514 013 004 0- 9 RL3514MB-9	4613159142	
	3514 009 005 0	DAF 1518057	All portsM16x1.5
	RL3514MD	M/S 0034319305	pred 0,25par Fixed
	4613074390		
		HINO 47160-2452	All ports RC3/8"
	RL3514NB		Angle 28"



DOUBLE ACTING CYLINDER



ΦΥΣΟΥΝΑΚΙΑ ΚΛΑΠΕ

ΕΙΚΟΝΑ	ΚΩΔΙΚΟΣ	ΕΦΑΡΜΟΓΗ	ΠΕΡΙΓΡΑΦΗ
	422010140	DAF 1517946	ΦΥΣΟΥΝΑΚΙ ΜΕ ΣΦΑΛΙΑΡΑ
		M/S 0002607063	ports41,42,=M12x1.5
		ZF 0501002209	
	4220100100	DAF 106321	ΦΥΣΟΥΝΑΚΙ ΧΩΡΙΣ ΣΦΑΛΙΑΡΑ
		IVECO 02981151	ports41,42,=M12x1.5
		MAN 81327356011	





CONTROL CYLINDER





ΦΥΣΟΥΝΑΚΙΑ ΚΛΑΠΕ

ΕΙΚΟΝΑ	ΚΩΔΙΚΟΣ	ΕΦΑΡΜΟΓΗ	ΠΕΡΙΓΡΑΦΗ
	4214120040	M/S 0003530255	ΦΥΣΟΥΝΑΚΙ ΚΛΑΠΕ
	AG3535A		
		ACTROS	ΦΥΣΟΥΝΑΚΙ ΚΛΑΠΕ
	2440-05		

ΕΙΚΟΝΑ	ΚΩΔΙΚΟΣ	ΕΦΑΡΜΟΓΗ	ΠΕΡΙΓΡΑΦΗ
	206-55550	MAN 81157016003	ΦΥΣΟΥΝΑΚΙ ΚΛΑΠΕ ports M12x1.5 Dia 28mm
	SZ1114	M/S 0004301826	
	2135 004 001 0		
	2135 005 001 0		ΦΥΣΟΥΝΑΚΙΑ ΓΚΑΖΙΟΥ ports M12x1.5 (6mm) Dia 24mm ports M12x1.5 (8mm)
	SZ1115		
	SZ1159		







DIRECTIONAL CONTROL VALVE









ΕΙΚΟΝΑ	ΚΩΔΙΚΟΣ	ΕΦΑΡΜΟΓΗ	ΠΕΡΙΓΡΑΦΗ
	1705 012 001 0	MAN	ΠΛΑΚΕΤΑ ΣΑΣΜΑΝ
	5710031040	DAF	
		M/S IVECO	
	1705 085 001 0	MAN 81521316015	ΠΛΑΚΕΤΑ ΣΑΣΜΑΝ ports 1 M12x1.5 ports 41 M10x1.5
	670046	ZF 050128630	
	1705 007 001 0	M/S 0012603	ΠΛΑΚΕΤΑ ΣΑΣΜΑΝ ports 1 M12x1.5 ports 41 M10x1.5
	RL1705RA	ZF 0501204597	
	4630630030		
	1705 050 001 0	M/S0012602757	ΠΛΑΚΕΤΑ ΣΑΣΜΑΝ ports M12x1.5
	RL1705WA	DAF 0609715	
	SV3302	MAN 81327346007	
	2458-04		
	1705 051 001 0	M/S 0012608457	ΠΛΑΚΕΤΑ ΣΑΣΜΑΝ ports 1,21,22: M12x1.5
	RL1705XA		
	SV3371		
	1705 052 001 0	M/S 0012600057	ΠΛΑΚΕΤΑ ΣΑΣΜΑΝ ports M12x1.5
	RL1705YA	IVECO 42486086	
	SV3360		
	4630460030		
	1705 053 001 0	M/S 0012606757	ΠΛΑΚΕΤΑ ΣΑΣΜΑΝ ports 1: M12x1.5 ports 21,22: M14x1.5
	RL1705ZA		
	SV3367 (SV3368-2)		
	1705 078 001 0	M/S 0022606157	ΠΛΑΚΕΤΑ ΣΑΣΜΑΝ ports 1,21,22: F10
	RL1705B01		
	1705 060 001 0	SCANIA 1319557	ΠΛΑΚΕΤΑ ΣΑΣΜΑΝ ports 1/8" NPT
	RL1705JA01		
	AG0031-C		

ΕΙΚΟΝΑ	ΚΩΔΙΚΟΣ	ΕΦΑΡΜΟΓΗ	ΠΕΡΙΓΡΑΦΗ
	1705 054 001 0	VOLVO 1068951	
	RL1705MA01	1669297	Supply 1:1/8" PT
		8172627	Delivery 2:1/8" PT
	1705 055 001 0	VOLVO 1669277	
	RL1705TA01	3092123	ports1,2 M10X1 M16X1.5,
	1669324		
	1705 055 003 0	VOLVO	
	RL1705TA03		ports1,2:Φ10.1
	1672231		
	1705 062 001 0	MAN 81521636006	
	RL1705JC01	IVECO 504010668	ports1,21,22: M12X1.5,
	SV3336		
	1705 016 001 0	M/S 0012606357	
	4630690030		



DIRECTIONS CONTROL VALVE

ΜΠΟΥΤΟΝ ΚΛΑΠΕ



ΕΙΚΟΝΑ	ΚΩΔΙΚΟΣ	ΕΦΑΡΜΟΓΗ	ΠΕΡΙΓΡΑΦΗ
	3548 022 001 0	VOLVO	OVER
	RL3548TC01		Supply 1:M10X1.5,
	1653156		Delivery 2:M10X1.5,
	3548 010 001 0	VOLVO268759	OVER
	RL3548MA	DAF 0642909	ports1,2: M10X1
	4630220200		
	3548 001 022 0	DAF 0639394	ΜΠΟΥΤΟΝ ΚΛΑΠΕ
	RL3548AG22	M/S 0004340501	ports1,2,3: M12X1,5
	4630131160	IVECO 02564594	
	4630131240	MAN NEOPLAN	
	35480010030	VOLVO 1132041	ΜΠΟΥΤΟΝ ΚΛΑΠΕ
	RL3548AG	DAF 1518078	ports1,2,3: M12X1,5
	4630131140	M/S 0004300509	
	AE 1207		
	3548 014 001 0	M/S 0004343801	ΜΠΟΥΤΟΝ ΚΛΑΠΕ
	RL3548NA	DAF 1505077	ports1,2:M16X1,5
	4630132000		port3:M12X1,5Voss
	3548 013 001 0	M/S 0039977036	ΜΠΟΥΤΟΝ ΚΛΑΠΕ
	RL3548PA	DAF1505078	ports1,21:M16X1,5 Voss
	463 013 210 0		port3:M12X1,5
	1705 009 001 0	M/S 0039979136	ΜΠΟΥΤΟΝ ΚΛΑΠΕ
	RL1705UA	DAF1518085	ports1,21,22:M10X1
	4630370010		

ΕΙΚΟΝΑ	ΚΩΔΙΚΟΣ	ΕΦΑΡΜΟΓΗ	ΠΕΡΙΓΡΑΦΗ
	3533 001 005 0	RVI 500039138	
	RL3533AE	VOLVO 79379137	ports11,12,2:M22X1,5
	434208000		
	3533 001 003 0	RVI 5000436340	
	RL3533AC	VOLVO 1505044	ports11,12,2:M16X1,5
	4342080090		
	3533 001 001 0	KING LONG	
	RL3533AA		ports11,12,2: 3/8 NPT
		DAF1619672	
	RL3533LB	M/S0044292244	ports11,12,2:M16X1,5
	4342080300		
	35330090010	RVI50000039183	
	RL3533LA	VOLVO 21795800	ports11,12,2:M22X1,5
	AE4100	MAN8154306043	
	4342080290	IVECO1236222	
	3533 006 002 0		
	RL3533HB		ports11,12,2:M16X1,5
	3533 006 001 0 RL3533HA		ports11,12,2:3/8" PT
	3533 006 0030 RL3533HC (278615)		ports11,12,2:1/4" PT
	35330030010		
	RL3533EA		Ports SUP DEL CON:1/4" PT
	MC821909		
	3513 008 001 0 RL3513HA	KX175/1	155 psi (11 bar)port:1/4"N PT
	3513 008 0020 0 RL3513HB	KX175/2	155 psi (11 bar)port:M16X1.5

CHECK VALVE





ΕΙΚΟΝΑ	ΚΩΔΙΚΟΣ	ΕΦΑΡΜΟΓΗ	ΠΕΡΙΓΡΑΦΗ
	3525 001 001 0	1.417.035.600.060	
	RL3525AA		ports1,2:M22X1,5
	4341000000 434001001		
	3525 002 002 0		
	RL3525DB		ports1 M22X1,5, M22X1,5
	RL3525ZA	UNIVERSAL	portsSuply delivery:1/2" PT
	KN23000 227871		
	RL3525ZB		portsSuply delivery:1/4" PT

DRAIN VALVE

ΕΙΚΟΝΑ	ΚΩΔΙΚΟΣ	ΕΦΑΡΜΟΓΗ	ΠΕΡΙΓΡΑΦΗ
	EE4106		
	3536 001 001 0		
	934 3000 030		
	076.249-00		

ΕΙΚΟΝΑ	ΚΩΔΙΚΟΣ	ΕΦΑΡΜΟΓΗ	ΠΕΡΙΓΡΑΦΗ
	3526 001 110 0	M/S 0024302481	ΧΕΙΡΟΦΡΕΝΟ
	RL3526CK04	DAF	Ports11,21, M14X1,5-6H
	961 722 275 0		Installation hole 2xm8x1.25-6H
	3526 001 114 0	M/S3884307709	ΧΕΙΡΟΦΡΕΝΟ
	RL3526CK06		Ports11,21,22 M14X1,5
	961 722 315 0		Exhaust Hole Φ8.5
	3526 001 037 0	NATO	ΧΕΙΡΟΦΡΕΝΟ
	RL3526CK37	VOLVO 1598586	Ports11,21,22 M14X1,5-6H
	961 722 305 0		Installation hole 2xM6-6H Installation hole Spacing 80mm
	3526 010 001 0	DAF 1518221	ΧΕΙΡΟΦΡΕΝΟ
	RL3526RA	M/S 0004309581	Ports Slide Lock
	961722 212 0 HB1173		
	3526 010 002 0	DAF 1524289	ΧΕΙΡΟΦΡΕΝΟ
	RL3526RB	M/S 0004309681	Ports Slide Lock
	961 722 232 0 HB1168		
	3526 001 016 0	MAN 112232900	ΧΕΙΡΟΦΡΕΝΟ
	RL3526EK	IVECO 4841086	Ports11,21,22 M14X1,5
	961722 258 0 HB1179		
	3526 005 0010	DAF1500	ΧΕΙΡΟΦΡΕΝΟ
	RL3526DX	MAN 81523156113	Ports1,21,22 M16X1,5 Parker
	Kit 35260050019 9617230002		
	3526 005 002 0	DAF 0559817	ΧΕΙΡΟΦΡΕΝΟ
	RL3526DY		Ports1,21,22 M16X1,5 Parker
	961 723 108 0 Kits RL3526DY-9		
	3526 005 0510	DAF 1518233	ΧΕΙΡΟΦΡΕΝΟ
	RL3526DX07	MAN 81523156113	Break 73 Voss Push Fiting
	961 723 100 0 HB1500	NATO 2530123122719	
	3526 006 002 0	DAF 1518235	ΧΕΙΡΟΦΡΕΝΟ
	RL3526NB	M/S 0024307581	Ports3X M16X1,5 VOSS
	961 723 104 0 HB1510 Kit3526 006 002 0 9 961 723 C		
	3526 006 005 0	DAF 1505334	ΧΕΙΡΟΦΡΕΝΟ
	RL3526NE	IVECO 8137037	Ports2X M16X1,5 Parker
	DPM94 AAX		

ΕΙΚΟΝΑ	ΚΩΔΙΚΟΣ	ΕΦΑΡΜΟΓΗ	ΠΕΡΙΓΡΑΦΗ
	3526 002 010 0	IVECO 101741	ΧΕΙΡΟΦΡΕΝΟ
	RL3526AK		Ports :1,2 M14X1,5
	9617221510		
	HB 1203 / 325017001	Kits RL3526AK-9 3526 004 010 9 961722 0022	
	3526 002 150 0	M/S3844307309	ΧΕΙΡΟΦΡΕΝΟ
	RL3526AK01		Ports :1,2 M14X1,5
	9617221820		
	3526 002 112 0	SCANIA 436190	ΧΕΙΡΟΦΡΕΝΟ
	RL3526BK		Ports :1,2 M14X1,5
	9617221500		
	HB1180		
	3526 004 155 0	DAF 1505331	ΧΕΙΡΟΦΡΕΝΟ
	RL3526BA	VOLVO 6702610	Ports :1,2 M16X1,5
	96117230040		
	3526 004 002 0	DAF 0371274	ΧΕΙΡΟΦΡΕΝΟ
	RL3526BB	IVECO 500002949	Ports :1,2 M16X1,5
	96117230010	MAN M225975	
	3526 001 011 0	IVECO 228235	ΧΕΙΡΟΦΡΕΝΟ
	RL3526CK	DAF 374642	Ports 11,21,22M14X1,5
	961 722 252 0	M/S 0014300281	
	HB1201/ 328019001		
	3526 001 113 0	SCANIA 390286	ΧΕΙΡΟΦΡΕΝΟ
	RL3526CK05		Ports 1,21,22M14X1,5
	961 722 3140		
	3526 001 104 0	M/S 3644307181	ΧΕΙΡΟΦΡΕΝΟ
	RL3526CK03		Ports11,12,21,23 M14X1,5
	961 722 284 0		
	3526 043 001 0	M/S	ΧΕΙΡΟΦΡΕΝΟ
	RL3526XD01		All Ports hole 6xΦ10
	DPM64MP		Installation Φ7
	3526 006 043 0	IVECO SPR1	ΧΕΙΡΟΦΡΕΝΟ
	RL3526NE-B	RVI 5010422400	Ports1,21,22Thread M16X1,5
	DPM28A		Installation hole M8X1
	3526 041 001 0	DAF	ΧΕΙΡΟΦΡΕΝΟ
	RL3526XB01	SCANIA1324425	Ports2X M16X1,5-6H
	9617231220		Installation hole M6 4XΦ9/2XΦ6.5
	3526 042 001 0	DAF 1519266	ΧΕΙΡΟΦΡΕΝΟ
	RL3526XC01	M/S 0034307381	All Ports M16X1.5
	9617231250	Actros	Installation hole 2XM8
			Parking position 73

ΕΙΚΟΝΑ	ΚΩΔΙΚΟΣ	ΕΦΑΡΜΟΓΗ	ΠΕΡΙΓΡΑΦΗ
	3526 030 001 0		ΧΕΙΡΟΦΡΕΝΟ
	RL3526QL01		All Ports M14X1.5
	HB1242		Mounting M6
	3526 020 002 0	VOLVO 4822431	ΧΕΙΡΟΦΡΕΝΟ
	RL3526VB	DAF1506443	Ports 1,2 M12X1,5
	9617210040	MAN 81523156165	Exhaust Hole Φ8
	Kits 9617010002	SCANIA405673	Installation hole M6
	3526 008 001 0	SCANIA 400555	ΧΕΙΡΟΦΡΕΝΟ
	RL3526PA	MAN 11026530099	All Ports M14X1.5
	9617011000	IVECO 2498634	
	HB1132 328009111		
	3526 008 003 0	DAF 0360774	ΧΕΙΡΟΦΡΕΝΟ
	RL3526PC	M/S 0004308581	All Ports M14X1.5
	9617020040	NEOPLAN1102656544010	Coment Right Hant
	Kit 35260080030 9 9617020012		
	3526 020 001 0	DAF 1524300	ΝΤΑΛΙΚΟΦΡΕΝΟ
	RL3526VA	MAN81523156068	Ports 1,2 M14X1,5 Parker
	9617210000		Kit 35260200010 9617210082





ROTARY SLIDE VALVE







ΧΕΙΡΙΣΤΗΡΙΑ

ΕΙΚΟΝΑ	ΚΩΔΙΚΟΣ	ΕΦΑΡΜΟΓΗ	ΠΕΡΙΓΡΑΦΗ
	8606 002 001	VOLVO 6773736	ΧΕΙΡΙΣΤΗΡΙΟ
	RL8606BA	IVECO42089956Schmitz506	Ports 1 M16X1,5 All Others M12X1.5
	4630320200	MAN1065259KOGEL77414	Kits RL8606BA 9 4630320012
	SV3113 338021001	KRONE 500945047	
	8606 008 001	DAF	ΧΕΙΡΙΣΤΗΡΙΟ
	RL8606GA	LEYLAND 3300	All Ports M16X1,5
	SV3111	DAIMLER LK	
	4630320000	SCHMITZ 050506	



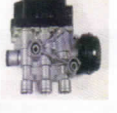

ECAS HEIGHT SENSORS

ΒΑΛΒΙΔΕΣ ΑΝΑΡΤΗΣΗΣ

ΕΙΚΟΝΑ	ΚΩΔΙΚΟΣ	ΕΦΑΡΜΟΓΗ	ΠΕΡΙΓΡΑΦΗ
	2908 013 001 0	DAF 1305844	ΒΑΛΒΙΔΑ ΑΝΑΡΤΗΣΕΙΣ ECAS
	RL2908NA01	IVECO 98472878	
	441 050 011 0	MAN 81259370016	
	2908 013 002 0	DAF 150505054	ΒΑΛΒΙΔΑ ΑΝΑΡΤΗΣΕΙΣ ECAS
	RL2908NA02	IVECO 500340806	
	441 050 012 0	KOGEL69093KRONE581597	
	2908 013 003 0	DAF1247631	ΒΑΛΒΙΔΑ ΑΝΑΡΤΗΣΕΙΣ ECAS
	RL2908NA03	MAN 812593700100	
	441 050 008 0	M/S 0105427817	
	4101 501 007 0	MAN 81259370040	ΒΑΛΒΙΔΑ ΑΝΑΡΤΗΣΕΙΣ ECAS
	RLDM-M041		
	441 050 123 0		
	4101 099 002 0	DAF 1365935	ΒΑΛΒΙΔΑ ΑΝΑΡΤΗΣΕΙΣ ECAS
	RLD5-M042	RVI 5010422344	
	4410501000		

ΕΙΚΟΝΑ	ΚΩΔΙΚΟΣ	ΕΦΑΡΜΟΓΗ	ΠΕΡΙΓΡΑΦΗ
	RL3754EC02	DAF 1302682	ΒΑΛΒΙΔΑ ECAS
	4729000530	IVECO 5000310195	All Ports M22X1,5 DC 24V
		MAN 81259026146	Max Working pressure 20bar
	RL3754EC01	DAF 1193658	ΒΑΛΒΙΔΑ ECAS
	4729000560	IVECO50006302001	All Ports M22X1,5 DC 24V
		VOLVO 203554	Max Working pressure 20bar
		MAN 81259026168	
	RL3754EC03	DAF 1506180	ΒΑΛΒΙΔΑ ECAS
	4729000600	M/S 0003276725	All Ports M22X1,5 DC 24V
			Max Working pressure 20bar
	RL3754EC04	DAF 1505294	ΒΑΛΒΙΔΑ ECAS
	4729000620	SCANIA 1383956	All Ports M22X1,5 DC 24V
			Max Working pressure 20bar
	RL3754EC20	MAN 81259026158	ΒΑΛΒΙΔΑ ECAS
	4729000570	81259029158	All Ports M22X1,5 DC 24V
	RL3754EC18	DAF1506182	ΒΑΛΒΙΔΑ ECAS
	4729001130	SCANIA 1383957	All Ports M22X1,5 DC 24V
		1404397	Max Wornig pressure 20bar
	RL3754EC100	IVECO 97106463	ΒΑΛΒΙΔΑ ECAS
	4729000010	MAN 81259026154	All Ports M22X1,5 DC 24V
		M/S 0003276225 ΝΕΟΡΛΑΝ	

SOLENOID RAISE / LOWER VALVE CONTROL (ΤΑΚΟΙ)













ΕΙΚΟΝΑ	ΚΩΔΙΚΟΣ	ΕΦΑΡΜΟΓΗ	ΠΕΡΙΓΡΑΦΗ
	8606 004 001 0	VOLVO 3944186 8143448	ΤΑΚΟΣ ΑΝΑΡΤΗΣΕΙΣ
	RL8606DA		Ports 1M16X1.5 3MX221.5
	338050101	Kits RL8606DA 9	Ports11,12,13,21,22 M12X1.5
	3754 045 001 0	VOLVO 3944716	ELC ELECOTRNIC VALVE
	RL3754EL01		ΤΑΚΟΣ ΑΝΑΡΤΗΣΕΙΣ
	0501 100 031 000		Ports1,21,22M16X1.5 Installation hole 2XΦ10
	375 045 005 0	VOLVO B7R B10M 3944717	ELC ELECOTRNIC VALVE
	RL3754EL05		ΤΑΚΟΣ ΑΝΑΡΤΗΣΕΙΣ
	0501 100 029 000		Ports1,21,22,23M16X1.5
	8606 005 001 0	EVOBUS 8025172000	RAISE / LOWER VALVE
	338021001	MAN 814361060014	Ports1,3M14X1.5
	4630320200	SCANIA 1738469	Other PortsM12X1.5
	RL3548KA	DAF 0867872	LIFT AXLE CONTROL VALVE
	4630840000	MAN ZG046200002	ΒΑΛΒΙΔΑ ECAS
	352028014		Ports 20M22X1.5All Others M16X1.5 Coment Switch Pressure Adjustable (2-7)bar

ΕΙΚΟΝΑ	ΚΩΔΙΚΟΣ	ΕΦΑΡΜΟΓΗ	ΠΕΡΙΓΡΑΦΗ
	2908 004 001 0	TRAIL	ΒΑΛΒΙΔΑ ΑΝΑΡΤΗΣΕΙΣ
	RL2908DA		Ports 11,21,M12X1,5
	SV1280		Ports 12,23M16X1,5
	2908 004 005 0	DAF M/S TRUCK	ΒΑΛΒΙΔΑ ΑΝΑΡΤΗΣΕΙΣ
	RL2908DA05		Ports All M12X1,5
	SV1281		
	2908 002 001 0	TRAIL	ΒΑΛΒΙΔΑ ΑΝΑΡΤΗΣΕΙΣ
	RL2908BA		Ports All M12X1,5
	4640025120/4640025320		
	SV1294	kit 29080020010-9	
	2908 003 001 0	SCANIA 0426380	ΒΑΛΒΙΔΑ ΑΝΑΡΤΗΣΕΙΣ
	RL2908CA	VOLVO 3038069 8030222	Ports All M12X1,5
		MAN 81436106061	
	SV1295		
	2908 002 002 0	TRAIL	ΒΑΛΒΙΔΑ ΑΝΑΡΤΗΣΕΙΣ
	RL2908BB		Ports All M12X1,5
	SV1310		160MM
	2908 003 002 0	DAF 1518856	ΒΑΛΒΙΔΑ ΑΝΑΡΤΗΣΕΙΣ
	RL2908CB	IVECO 04675513	Ports All M12X1,5
	SV1318 4640040000	RVI 5021170185	
	Kit 29080030020-9 i86534		
	2908 002 003 0	TRAIL	ΒΑΛΒΙΔΑ ΑΝΑΡΤΗΣΕΙΣ
	RL2908BB-A		Ports All M12X1,5
	SV1361		
	2908 001 001 0	SCANIA 339792	ΒΑΛΒΙΔΑ ΑΝΑΡΤΗΣΕΙΣ
	RL2908AA	MAN 4027060	Ports All M12X1,5
	464 006 002 0	IVECO IT4358	
	SV1307 612017091	KRONE 945351	
	2908 001 007 0	DAF1325336	ΒΑΛΒΙΔΑ ΑΝΑΡΤΗΣΕΙΣ
	RL2908AA07	MAN1260680	Ports 1,21,22M12X1,5
	464 006 100 0	KRPNE 5808613	Ports 12,23M16X1,5
	SV1410	KOGEL318955	
	2908 001 002 0	DAF1506114	ΒΑΛΒΙΔΑ ΑΝΑΡΤΗΣΕΙΣ
	RL2908AB	VOLVO 1607728	Ports All M12X1,5
	464006000		
	Kit 29080010010-9 4640060002		
	2908 006 001 0	KRONE9451430	ΒΑΛΒΙΔΑ ΑΝΑΡΤΗΣΕΙΣ
	RL2908FA	VOLVO 1576736	Ports 1,21,22M12X1,5
	464 002 330 0	MAN 1065236	
	SV1211	IVECO222685	
	29808 006 009 0	MAN 3320	ΒΑΛΒΙΔΑ ΑΝΑΡΤΗΣΕΙΣ
			Ports 1,21,22M12X1,5
	464 002 312 0		Ports 12,13 M16X1.5

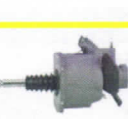
EIKONA	ΚΩΔΙΚΟΣ	ΕΦΑΡΜΟΓΗ	ΠΕΡΙΓΡΑΦΗ
	2908 005 001 0	SCANIA	ΒΑΛΒΙΔΑ ΑΝΑΡΤΗΣΕΙΣ ΚΟΥΒΟΥΚΛΙΟΥ Ports NPT 1/8
	90054007		
	2908 015 001 0	M/SA0003282130	ΒΑΛΒΙΔΑ ΑΝΑΡΤΗΣΕΙΣ ΚΟΥΒΟΥΚΛΙΟΥ
	FA050005001	.0500005002 R	Ports M12X1,5
	29080150020	M/S 303-404 .0500005001 L	
	2908 010 001 0	Heavy Duty Truck	ΒΑΛΒΙΔΑ ΑΝΑΡΤΗΣΕΙΣ
	RL2908KA		Ports 1,21,22 NPT 1/4
	90554241	RL2908KA-9 29080100010-9	
	2908 010 002 0	Heavy Duty Truck	ΒΑΛΒΙΔΑ ΑΝΑΡΤΗΣΕΙΣ
	RL2908KB		Ports 1,21,22M12X1,5
	90554243	RL2908KB-9 29080100020-9	
	2908 007 001 0	SCANIA 1399776	ΒΑΛΒΙΔΑ ΑΝΑΡΤΗΣΕΙΣ ΚΟΥΒΟΥΚΛΙΟΥ Ports All M10X1,5
	464 007 010 0		
	2908 007 002 0	VOLVO 8141934	ΒΑΛΒΙΔΑ ΑΝΑΡΤΗΣΕΙΣ ΚΟΥΒΟΥΚΛΙΟΥ
	RL29908GB		Ports All M10X1,5
	464 007 002 0		
	2908 007 019 0	DAF	ΒΑΛΒΙΔΑ ΑΝΑΡΤΗΣΕΙΣ ΚΟΥΒΟΥΚΛΙΟΥ
	464 007 030 0	IVECO	Ports 1,2 Φ6
		MAN	Installation Hole 2XFΦ.5
		M/S	
	2908 007 006 0	DAF	ΒΑΛΒΙΔΑ ΑΝΑΡΤΗΣΕΙΣ ΚΟΥΒΟΥΚΛΙΟΥ
	464 007 001 0	IVECO	Ports 1,2 Φ6
		MAN	
		M/S	
	2908 007 032 0	RVI 501026060	ΒΑΛΒΙΔΑ ΑΝΑΡΤΗΣΕΙΣ ΚΟΥΒΟΥΚΛΙΟΥ
	464 007 008 0	7420745592	Ports 1,2 Φ6
	2908 007 003 0	M/S A0003284530Z00	ΒΑΛΒΙΔΑ ΑΝΑΡΤΗΣΕΙΣ ΚΟΥΒΟΥΚΛΙΟΥ
	RL29908GC		Ports All M10X1,5
	464 007 011 0		
	2908 011 002 0	IVECO	ΠΕΡΙΟΡΙΣΜΟΥ ΑΝΑΡΤΗΣΕΙΣ
	RL2908YA02	SCHMIKZ 50049	Ports :All M12X1,5
	AE1103		Road end:M8
	964 001 002 0		
	2908 011 001 0	IVECO RVI	ΠΕΡΙΟΡΙΣΜΟΥ ΑΝΑΡΤΗΣΕΙΣ
	RL2908YA01		Ports :All M12X1,5
	AE1122		Road end:M8

ΕΙΚΟΝΑ	ΚΩΔΙΚΟΣ	ΕΦΑΡΜΟΓΗ	ΠΕΡΙΓΡΑΦΗ
	1608 044 012 0 RL1608PA03 9700511110	MAN 81307256014	ΣΕΒΡΟ ΑΜΠΡΑΓΙΑΖ Dia 75 mm stroke 85mm Air M16X1.5 Hyd M14X1.5
	RL1608CA VG3200 9700511110 Kit RL1608PC-9 I84613	MAN F80 F81 IVECO	ΣΕΒΡΟ ΑΜΠΡΑΓΙΑΖ Dia 75 mm stroke 85mm Air 11 M16X1.5 Hyd M14X1.5
	1608 045 004 0 RL 1608PR 9700511020 193581	MAN 81307256014	ΣΕΒΡΟ ΑΜΠΡΑΓΙΑΖ Dia 76.5 mm stroke 85mm Air 11 M16X1.5 Hyd M14X1.5
	1608 047 001 0 RL1608PT 9700511830 Kits 1608047001-9 RL1608PT-9 9700519102	DAF1506460 ZF 0501006545	ΣΕΒΡΟ ΑΜΠΡΑΓΙΑΖ Dia 76.5 mm stroke 85mm Air 11 M16X1.5 Hyd M14X1.5
	1608 045 001 0 RL1608PC 9700511140 Kits 1608045001-9 RL1608PC-9 9700519042	IVECO 1261885 DAF 0659807 ZF 0501202572	ΣΕΒΡΟ ΑΜΠΡΑΓΙΑΖ Dia 76.5 mm stroke 67mm Air 11 M16X1.5 Hyd M14X1.5
	1608 045 004 0 RL1608PR 9700511020 VG3204 Kits 16080450040-9 RL1608PR-9 9700519042	DAF 0658882 IVECO 07476623 M/S 6992950018	ΣΕΒΡΟ ΑΜΠΡΑΓΙΑΖ Dia 76.5 mm stroke 67mm Air 11 M16X1.5 Hyd M14X1.5
	1608 044 002 0 RL1608PB 9700511560	ZF 0501005065	ΣΕΒΡΟ ΑΜΠΡΑΓΙΑΖ Dia 76.5 mm stroke 85mm Air 11 M16X1.5 Hyd M14X1.5
	1608 044 006 0 RL 1608PK 9700511370 Kits RL1608PK-9 9700519102	DAF 1518249 M/S 0002950018	ΣΕΒΡΟ ΑΜΠΡΑΓΙΑΖ Dia 76.5 mm stroke 85mm Air 11 M16X1.5 Hyd M14X1.5
	1608 048 001 0 RL1608PS 9700511510 Kit 1608048001-9 RL1608PS-9	DAF 1518250 M/S 0002950818	ΣΕΒΡΟ ΑΜΠΡΑΓΙΑΖ Dia 85 mm stroke 65mm Air 11 M16X1.5 Hyd M14X1.5
	VG3208 FA7007A	MAN 81.30725.6053	ΣΕΒΡΟ ΑΜΠΡΑΓΙΑΖ Dia 100 mm stroke
	1608 044 003 0 RL1608PG 9700511700 Kit 16080440030-9RL1608PG-9 9700519192	MAN 81307256062	ΣΕΒΡΟ ΑΜΠΡΑΓΙΑΖ Dia 102 mm stroke 85mm Air 11 M16X1.5 Hyd M14X1.5
	1608 044 004 0 RL1608PH 9700511520 Kits 16080440040-9 RL1608PH-9 9700519112	NEOPLAN 042320800 M/S0002952318	DIA 102 STROKE 85MM Air 11 M16X1.5 Hyd M14X1.5









ΕΙΚΟΝΑ	ΚΩΔΙΚΟΣ	ΕΦΑΡΜΟΓΗ	ΠΕΡΙΓΡΑΦΗ
	1608 044 016 0	DAF 1518251	ΣΕΒΡΟ ΑΜΠΡΑΓΙΑΖ
	RL1608PA06	MAN 81307256053	Dia 102 mm stroke 85mm
	9700511570	VG3229 II14194	Air M16X1.5 Hyd M14X1.5
	1608 042 002	DAF1506466	ΣΕΒΡΟ ΑΜΠΡΑΓΙΑΖ
	RL1608EE	SCANIA 1935601	Dia 102 mm stroke 85mm
	9700514230	ZF 0501006570	Air M16X1.5 Hyd M14X1.5
	Kits16080530139 RL1608EE-9 9700519432		
	1608 043 003 0	M/S A002952818	ΣΕΒΡΟ ΑΜΠΡΑΓΙΑΖ
	RL1608EC01		Dia 102 mm stroke 85mm
	9700514310 (405 0)		Air M16X1.5 Hyd M14X1.5
	FA7012A	Kits 1608043001-9 RL1608EC-9 97200519492	
	16080420040	MAN 81307256065	ΣΕΒΡΟ ΑΜΠΡΑΓΙΑΖ
	RL1608EH		Dia 102 mm stroke 85mm
	9700514140 II31733		Air M22X1.5 Hyd M14X1.5
	FA7032A		
	1608 044 005 0	NEOPLAN 042321100	ΣΕΒΡΟ ΑΜΠΡΑΓΙΑΖ
	RL1608PJ	ZF 0501004575	Dia 102 mm stroke 85mm
	9700511650		Air 11 M16X1.5 Hyd M14X1.5
	Kits 16080440050-9 RL1608PJ-9 9700519442		
	1608 053 001 0	DAF 1518244	ΣΕΒΡΟ ΑΜΠΡΑΓΙΑΖ
	RL1608PE	IVECO 5000787875	Dia 102 mm stroke 58mm
	9700511240	RVI 5000787875	Air 11 M16X1.5 Hyd M14X1.5
	Kits 1608053010-9 RL1608PE-9 9700519062		
	1608 045 005 0	SCANIA 343362	ΣΕΒΡΟ ΑΜΠΡΑΓΙΑΖ
	RL1608PL	345362	Dia 102 mm stroke 58mm
	9700511070		Air 11 M16X1.5 Hyd M14X1.5
	Kit 16080450050-9 RL1608PL-9 9700519062		
	1608 042 052 0	DAF1506465	ΣΕΒΡΟ ΑΜΠΡΑΓΙΑΖ
	RL1608EA15	MAN 81307256084	Dia 102 mm stroke 85mm
	9700514120		Air M22X1.5 Hyd m14X1.5
	FA7033A		
	1608 042 001 0	ZF 0501005852	ΣΕΒΡΟ ΑΜΠΡΑΓΙΑΖ
	RL1608EA		Dia 102 mm stroke 85mm
	9700514070		Air M16X1.5 Hyd m14X1.5
	ZF 0501005852		
	1608 040 001 0	M/S 0002951418	ΣΕΒΡΟ ΑΜΠΡΑΓΙΑΖ
	RL1608LA		Dia 102 mm stroke 76,8 mm
	VG 3361		Air M16X1.5 Hyd m14X1.5
	Kits 16080400010-9 RL1608LA- 9 14195008		
	1608 041 001 0	DAF 1506456	ΣΕΒΡΟ ΑΜΠΡΑΓΙΑΖ
	RL 1608LB	M/S 0002951518	Dia 102 mm stroke 70 mm
	9700511580		stroke 72 mm
	Kit 1608041110 9 RL1608LB 9 9700519162		
	1608 041 002 0		DAF 1505140
	RL1608LB-A		M/S 0002951518
	9700511590		Kit 1608041002
	1608 039 0010	DAF 1518247	
	9700511310		
	RL1608KA		

ΕΙΚΟΝΑ	ΚΩΔΙΚΟΣ	ΕΦΑΡΜΟΓΗ	ΠΕΡΙΓΡΑΦΗ
	1608 039 001 0	DAF 1518247	ΣΕΒΡΟ ΑΜΠΡΑΓΙΑΖ
	RL11608KA	M/S 0012953107	stroke 72 mm
	9700511310		Air M16X1.5 Hyd m14X1.5
	Kit 16080390010-9 RL11608KA-9 9700519032		
	1608 049 001 0	MAN VOLVO	Dia 80mm stroke 40
	RL1608XA	SCANIA	AIR 11 M16X1.5
	622785AM	DAF	Yyd (1-4) UNF 7/16-20
		Kit 1608 049 001 0-9	Push rod M12x1.5
	1608 050 004 0	626400AM 625291AM	Dia 100 mm stroke 85mm
	RL1608XC01	DAF 1241257 1327940	AIR 11 M16X1.5
	622508 AM	1346863 1443531	Air M16X1.5 Hyd m14X1.5
	1608 050 001 0	DAF	ΣΕΒΡΟ ΑΜΠΡΑΓΙΑΖ
	RL1608XB		Dia 100 mm stroke 85mm
			Air M16X1.5 Hyd m14X1.5
	1608 050 003 0	SCANIA 371612	ΣΕΒΡΟ ΑΜΠΡΑΓΙΑΖ
	RL1608XC	374116	Dia 100 mm stroke 70 mm
	622190AM	5751843	Air M16X1.5 Hyd m14X1.5
	1608 050 002 0	SCANIA 1331770	ΣΕΒΡΟ ΑΜΠΡΑΓΙΑΖ
	RL1608XD	1747895 575180	Dia 100 mm stroke 70 mm
	622199AM		Air 11 M16X1.5 Hyd m14X1.5
	628493AM	VOLVO	ΣΕΒΡΟ ΑΜΠΡΑΓΙΑΖ
	8171721	F7 F9 F10 F12 FH12	M16X1.5 M12X1.5
	FA7043A	3192126 - 8171721	
	1604 001 003 0	SCANIA 1367453	ΣΕΒΡΟ ΑΜΠΡΑΓΙΑΖ
	RL1604AA03	1421186	stroke Max 27.5 mm
	629683AM	1513717	Air Intel M16X1.5 Out-oil M14X1.5
	1608 057 001 0	RVI 5000050272	ΣΕΒΡΟ ΑΜΠΡΑΓΙΑΖ
	RL1608ZA01	5000130533	stroke Max 23 mm
	1642176708		Oil Intel M16X1.5 Energy supply b14X1.5
	1608 003 092 0	NISSAN	ΣΕΒΡΟ ΑΜΠΡΑΓΙΑΖ
	RL1608BM05	HINO	Dia 90 mm stroke 35 mm
	642-03502	MITSUBISHI	Ports 11, M14X1.5 14M12X1.5
	1608 001 014 0	NISSAN	ΣΕΒΡΟ ΑΜΠΡΑΓΙΑΖ
	RL1608AM	HINO	Dia 90 mm stroke 35 mm
	642-03080	MITSUBISHI	Ports 11, M14X1.5 14M12X1.5
	FA7003A		Installation hole 4XM10
	1608 058 0010 (1608 058 030)	VOLVO	Dia 80mm stroke 40 mm
	626392AM		Ports M12X1.5
	1608 058 0020		
	622639AM		

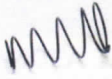

ΕΙΚΟΝΑ	ΚΩΔΙΚΟΣ	TYPE	ΕΦΑΡΜΟΓΗ	ΠΕΡΙΓΡΑΦΗ
	3519360010	12	DAF1505025	ΦΥΣΟΥΝΑ ΜΟΝ.ΕΝΕΡΓΕΙΑΣ
	RL3519NA		RVI 5021170046	ΑΞΟΝΑ
	4231039000		MAN 81511016203	stroke 57mm push rod Length 186 mm
	FA1012A			
	35198100010	16	4231049000	ΦΥΣΟΥΝΑ ΜΟΝ.ΕΝΕΡΓΕΙΑΣ
	RL3519YA1		DAF 0834481	ΑΞΟΝΑ
	4231039000		MAN 81511016172	stroke 75mm push rod Length 186 mm
	FA1011EA			ports2XM16X1.5
	35198200010	24	SCANIA 1010154	ΦΥΣΟΥΝΑ ΜΟΝ.ΕΝΕΡΓΕΙΑΣ
	RL3519ZA1		VOLVO 6212188	ΑΞΟΝΑ
	42310690000		M/S0014206824	stroke 75mm push rod Length 270 mm
	FA1008B		IVECO3345108R1	ports2XM16X1.5
	35190301420	20		ΦΥΣΟΥΝΑ ΜΟΝ.ΕΝΕΡΓΕΙΑΣ
	RL3519JA18			ΑΞΟΝΑ
	4231059000			stroke 54mm push rod Length 270 mm
	FA1010A			ports2XM16X1.5
	35190901000	30	RVI50000815361	ΦΥΣΟΥΝΑ ΜΟΝ.ΕΝΕΡΓΕΙΑΣ ΑΞΟΝΑ
	RL3519DA51		SCANIA 1010155	stroke 75mm push rod 186mm
	4231079000			ports2XM16X1.5
	FA1003A			
	35193000010	36		ΦΥΣΟΥΝΑ ΜΟΝ.ΕΝΕΡΓΕΙΑΣ ΑΞΟΝΑ
	RL3519LC			stroke 75mm push rod 184mm
				ports2XM22X1.5
	3519 210 073 0	16		ΦΥΣΟΥΝΑ ΜΟΝ.ΕΝΕΡΓΕΙΑΣ
	RL3519HA29			ΔΙΣΚΟΦΡΕΝΟΥ
				stroke 64mm push rod 15mm
				portsM16X1.5
	35190302670	20	DAF 1517954	ΦΥΣΟΥΝΑ ΜΟΝ.ΕΝΕΡΓΕΙΑΣ
	RL3519JA22		MAN N2504016063	ΔΙΣΚΟΦΡΕΝΟΥ
	4235050000		M/S 0074201224	stroke 57mm push rod Length 15 mm
	FA1020A			ports2XM16X1.5
	35190102110	24		ΦΥΣΟΥΝΑ ΜΟΝ.ΕΝΕΡΓΕΙΑΣ
	RL3519AM12			ΔΙΣΚΟΦΡΕΝΟΥ
	4325061500			stroke 65mm push rod 15mm
	FA1019A			ports M16X1.5
	25190901040	30	TRAILER	ΦΥΣΟΥΝΑ ΜΟΝ.ΕΝΕΡΓΕΙΑΣ
	RL3519DA35			ΑΕΡΟΥΔΡΑΥΛΙΚΟ ΜΕΤΑΤΡΟΠΗΣ
	4320570080			stroke 60mm push rod 46mm
				portsM16X1.5
	3519570003	24		ΦΥΣΟΥΝΑ ΜΟΝ.ΕΝΕΡΓΕΙΑΣ
	RL3519WD			ΧΕΙΡΟΦΡΕΝΟΥ
				stroke 72mm push rod 48.4mm
				ports M22X1.5
	35195700010	150	ATECO	ΦΥΣΟΥΝΑ ΜΟΝ.ΕΝΕΡΓΕΙΑΣ
	RL3519WA			ΧΕΙΡΟΦΡΕΝΟΥ
				stroke 72mm push rod 48.4mm
				ports M22X1.5

ΕΙΚΟΝΑ	ΚΩΔΙΚΟΣ	ΤΥΠΕ	ΕΦΑΡΜΟΓΗ	ΠΕΡΙΓΡΑΦΗ
	35304500150	16/24	M/S 0064201118	ΦΥΣΟΥΝΑ ΔΙΠΛΗΣ ΕΝΕΡΓΕΙΑΣ ΑΞΟΝΑ
	RL3530RA11		64203918	ΑΥΤΟΚΙΝΗΤΟΥ
	FA1034A			stroke 50/50 mm push rod Length159mm
	9253241010/9253240000			ports2XM16X1.5
	35304500050	16/24	M/S 015420918	ΦΥΣΟΥΝΑ ΔΙΠΛΗΣ ΕΝΕΡΓΕΙΑΣ ΑΞΟΝΑ
	RL35300RA1			ΤΥΠΟΥ WABCO
				stroke 57/57 mm push rod Length 270 ports2XM16X1.5
	35303900490	20/24		ΦΥΣΟΥΝΑ ΔΙΠΛΗΣ.ΕΝΕΡΓΕΙΑΣ ΑΞΟΝΑ
	RL3530PE49			ΑΥΤΟΚΙΝΗΤΟΥ
				stroke 50mm Thread 13/8-12UNS portsM16X1.5
	35300600870	24/24		ΦΥΣΟΥΝΑ ΔΙΠΛΗΣ ΕΝΕΡΓΕΙΑΣ ΑΞΟΝΑ
	RL3530CA11			ΤΥΠΟΥ WABCO
				stroke 57/57 mm push rod Length 270mm
	35300601790	24/24	VOLVO 1606835	ΦΥΣΟΥΝΑ ΔΙΠΛΗΣ ΕΝΕΡΓΕΙΑΣ ΑΞΟΝΑ
	RL3530CA80		20566204	
	9254310950			stroke 65/65 mm push rod Length 247mm
	35300603740	24/24		ΦΥΣΟΥΝΑ ΔΙΠΛΗΣ ΕΝΕΡΓΕΙΑΣ ΑΞΟΝΑ
				ΤΥΠΟΥ WABCO
	3530060093	24/24	M/S0064206818	ΦΥΣΟΥΝΑ ΔΙΠΛΗΣ ΕΝΕΡΓΕΙΑΣ ΑΞΟΝΑ
	RL3530CA17			stroke 57/57 mm push rod Length 290mm
	95253212020			ports2XM16X1.5
	FA1030A			
	35303010010	20/30		ΦΥΣΟΥΝΑ ΔΙΠΛΗΣ.ΕΝΕΡΓΕΙΑΣ ΑΞΟΝΑ
	9254500047			FIX VOSS ΚΟΥΜΠΟΤΟ
	925 490 121 7			stroke 50mm Thread 13/8-12UNS portsM16X1.5
		24/30		ΦΥΣΟΥΝΑ ΔΙΠΛΗΣ ΕΝΕΡΓΕΙΑΣ ΑΞΟΝΑ
	9253214070			ΑΥΤΟΚΙΝΗΤΟΥ
	FA1031A			stroke 64/64 mm push rod Length 340mm ports2XM16X1.5
	925322251			ΦΥΣΟΥΝΑ ΔΙΠΛΗΣ ΕΝΕΡΓΕΙΑΣ ΑΞΟΝΑ
	925 322241	30/30		ΑΥΤΟΚΙΝΗΤΟΥ
	925322251			stroke 64/64 mm push rod Length 340mm ports2XM16X1.5











ΕΙΚΟΝΑ	ΚΩΔΙΚΟΣ	TYPE	ΕΦΑΡΜΟΓΗ	ΠΕΡΙΓΡΑΦΗ
	3530 6300110 RL3530YY2 9254261010	.12/16	MAN81504106642 RVI510422316	ΦΥΣΟΥΝΑ ΔΙΠΛΗΣ ΕΝ. ΔΙΣΚΟΦΡΕΝΟΥ ΑΥΤΟΚΙΝΗΤΟΥ stroke 57/57 mm push rod Length 15 mm ports2XM22X1.5 Voss
	3530 2400010 RL3530SY1 9254860100	12/24	DAF1506228 M/S 0174209518	ΦΥΣΟΥΝΑ ΔΙΠΛΗΣ ΕΝ. ΔΙΣΚΟΦΡΕΝΟΥ ΑΥΤΟΚΙΝΗΤΟΥ stroke 57/57 mm push rod Length 96 mm
	35302410010 RL3530YZ1 9254262000	14/16	DAF1505437 MAN 81504106575	ΦΥΣΟΥΝΑ ΔΙΠΛΗΣ ΕΝ. ΔΙΣΚΟΦΡΕΝΟΥ ports2XM22X1.5 Voss
	35302410050	16/16		ΦΥΣΟΥΝΑ ΔΙΠΛΗΣ ΕΝ. ΔΙΣΚΟΦΡΕΝΟΥ Voss stroke 50mm portsM16X1.5
	35306900020 RL3530YX2 9254680120	.14/24	M/S0154205518	ΦΥΣΟΥΝΑ ΔΙΠΛΗΣ ΕΝ. ΔΙΣΚΟΦΡΕΝΟΥ stroke 57/57 mm push rod Length 15 mm ports2XM22X1.5 Voss
	35304520010 RL3530RY1 9254840210	16/24		ΦΥΣΟΥΝΑ ΔΙΠΛΗΣ ΕΝ. ΔΙΣΚΟΦΡΕΝΟΥ stroke 57/57 mm push rod Length 15mm ports2XM22X1.5 Voss
	35304520110 RL3530RY10 9524840100	16/24	M/S 0154206218	ΦΥΣΟΥΝΑ ΔΙΠΛΗΣ ΕΝ. ΔΙΣΚΟΦΡΕΝΟΥ stroke 57/57 mm push rod Length 15mm ports2XM22X1.5 Voss
	3530850010 RL3530YX11 9254612900	24/16	SCANIA 1516660	ΦΥΣΟΥΝΑ ΔΙΠΛΗΣ ΕΝ. ΔΙΣΚΟΦΡΕΝΟΥ stroke 65/64 mm push rod Length 15 mm portsM16X1.5
	35300601620 RL3530CA35 9254610000		M/S 015420918	ΦΥΣΟΥΝΑ ΔΙΠΛΗΣ ΕΝ. ΔΙΣΚΟΦΡΕΝΟΥ stroke 57/55 mm push rod Length 15mm ports2XM22X1.5 Voss
		24/24		ΦΥΣΟΥΝΑ ΔΙΠΛΗΣ ΕΝ. ΔΙΣΚΟΦΡΕΝΟΥ ΤΥΠΟΥ KNORR stroke 64/64 mm push rod Length 270mm ports2XM16X1.5
	35300900050 3530DZ1 1425324000001	27/24		ΦΥΣΟΥΝΑ ΔΙΠΛΗΣ ΕΝ. ΔΙΣΚΟΦΡΕΝΟΥ ΤΥΠΟΥ KNORR stroke 64/64 mm push rod Length 270mm ports2XM16X1.5

ΕΙΚΟΝΑ	ΚΩΔΙΚΟΣ	ΤΥΠΕ	ΕΦΑΡΜΟΓΗ	ΠΕΡΙΓΡΑΦΗ
	884 009 300 0	9/16	MAN	ΦΥΣΟΥΝΑ ΔΙΠΛΗΣ ΕΝΕΡΓΕΙΑΣ
	425 426 201 0		81 50410- 6548	ΔΙΣΚΟΦΡΕΝΟΥ
	FA1043A		81.50410-6548	stroke 50mm Thread 13/8-12UNS
			81.50410-6548	portsM16X1.5
	425 426 201 0	12/16	MAN	ΦΥΣΟΥΝΑ ΔΙΠΛΗΣ ΕΝΕΡΓΕΙΑΣ
	FA1042A		81.50410-6548	ΜΕ ΛΑΙΜΟ
			81504106548	stroke 50mm Thread 13/8-12UNS
			81 50410 6548	
	03.03.00.17	9/16		ΦΥΣΟΥΝΑ ΔΙΠΛΗΣ ΕΝΕΡΓΕΙΑΣ
	BY9104			ΜΕ ΠΛΑΚΑΚΙ
				ports M22X1.5 VOSS
	BY9154	10.5/16		ΦΥΣΟΥΝΑ ΔΙΠΛΗΣ ΕΝΕΡΓΕΙΑΣ
	BY9153			ΜΕ ΠΛΑΚΑΚΙ
				ports M22X1.5 VOSS
	03.15.00.04	12/16		ΦΥΣΟΥΝΑ ΔΙΠΛΗΣ ΕΝΕΡΓΕΙΑΣ
	4254540200			ΜΕ ΠΛΑΚΑΚΙ
	BY-9200			ports M22X1.5 VOSS
	FA1041A	16/16	M/S	ΦΥΣΟΥΝΑ ΔΙΠΛΗΣ ΕΝΕΡΓΕΙΑΣ
				ΜΕ ΠΛΑΚΑΚΙ
				stroke 50mm
	FA1062A	125	MAN	ΦΥΣΟΥΝΑ ΔΙΠΛΗΣ ΕΝΕΡΓΕΙΑΣ
	BZ6621			PUSH ROD 170MM
				portsM16X1.5
	FA 1003K	4.2MM	ΠΑΧΟΣ	ΕΛΑΤΗΡΙΟ ΦΥΣΟΥΝΑΣ ΚΑΠΑΚΙΟΥ
	T-10-12-2	12MM	ΠΕΙΡΟΣ	ΔΙΧΑΛΑ ΦΥΣΟΥΝΑΣ
	T-10-14-2	14MM	ΠΕΙΡΟΣ	

ΔΙΑΦΡΑΓΜΑΤΑ

ΕΙΚΟΝΑ	ΚΩΔΙΚΟΣ	ΤΥΠΕ	ΚΩΔΙΚΟΣ	ΚΩΔΙΚΟΣ	ΤΥΠΕ
	9120000090	9		91200000121	12
	9120000120	12			
	076410-10	14		076413-10	16
	91200000160	16		FA1049D2	20
	91200000200	20		91200000241	24
	91200000240-FA1049C1	24		076416-10	30
	91200000300-T30-1	30		0300114770 (ΤΕΜΠΕΛΗ)	36
	91200000360-FA1049A1	36			
		ΜΕΤΑΤΡΟΠΗΣ ΜΕΣΕΟ	91200000371	240MM	
		ΜΕΤΑΤΡΟΠΗΣ ΜΕΓΑΛΟ	91200000370	260MM	

ΕΙΚΟΝΑ	ΚΩΔΙΚΟΣ	ΤΥΠΕ	ΕΦΑΡΜΟΓΗ	ΠΕΡΙΓΡΑΦΗ
	35304510040	16/24	BMW0544440010	ΦΥΣΟΥΝΑ ΔΙΠΛΗΣ ΕΝΕΡΓΕΙΑΣ
	RL3530RB7			ΔΙΣΚΟΦΡΕΝΟΥ DALICAS 2 ΖΩΣΤΗΡΕΣ
	1351624004			stroke 57/57 mm push rod Length 15mm ports2XM16X1.5
	FA1037A	16/24	.0544440020 .0544440013	ΦΥΣΟΥΝΑ ΔΙΠΛΗΣ ΕΝΕΡΓΕΙΑΣ
				ΔΙΣΚΟΦΡΕΝΟΥ DALICAS 2 ΖΩΣΤΗΡΕΣ
				stroke 57/57 mm push rod Length 96 mm ports2XM16X1.5
	FA1060A	20/24		ΦΥΣΟΥΝΑ ΔΙΠΛΗΣ ΕΝΕΡΓΕΙΑΣ
	9254700000			ΔΙΣΚΟΦΡΕΝΟΥ DALICAS 2 ΖΩΣΤΗΡΕΣ
				stroke 57/57 mm push rod Length 96mm ports2XM16X1.5
	DN24/24	24/24		ΦΥΣΟΥΝΑ ΔΙΠΛΗΣ ΕΝΕΡΓΕΙΑΣ
				ΔΙΣΚΟΦΡΕΝΟΥ DALICAS 2 ΖΩΣΤΗΡΕΣ
				ports2XM16X1.5
	DN24/24	24/24		ΦΥΣΟΥΝΑ ΔΙΠΛΗΣ ΕΝΕΡΓΕΙΑΣ
				ΔΙΣΚΟΦΡΕΝΟΥ DALICAS 2 ΖΩΣΤΗΡΕΣ
				stroke 57/57 mm push rod Length 96mm ports2XM16X1.5
	FA1057A	24/30		ΦΥΣΟΥΝΑ ΔΙΠΛΗΣ ΕΝΕΡΓΕΙΑΣ ΑΞΟΝΑ
				DALICAS 2 ΖΩΣΤΗΡΕΣ
				stroke 57/57 mm push rod Length 285mm ports2XM16X1.5
	35302100140	20/24		ΦΥΣΟΥΝΑ ΔΙΠΛΗΣ ΕΝΕΡΓΕΙΑΣ ΑΞΟΝΑ
				DALICAS 2 ΖΩΣΤΗΡΕΣ
				stroke 64/64 mm push rod Length 270mm ports2XM16X1.5
	35301200360	24/30		ΦΥΣΟΥΝΑ ΔΙΠΛΗΣ ΕΝΕΡΓΕΙΑΣ ΑΞΟΝΑ
	RL3530EA15			DALICAS 2 ΖΩΣΤΗΡΕΣ
	35301200360			stroke 57/57 mm push rod Length 270mm ports2XM16X1.5
	35305400130	24/30		ΦΥΣΟΥΝΑ ΔΙΠΛΗΣ ΕΝΕΡΓΕΙΑΣ ΑΞΟΝΑ
				DALICAS 2 ΖΩΣΤΗΡΕΣ
	3530120089	24/30	DAF 925371000	ΦΥΣΟΥΝΑ ΔΙΠΛΗΣ ΕΝΕΡΓΕΙΑΣ ΑΞΟΝΑ
	RL3530EY15			DALICAS 2 ΖΩΣΤΗΡΕΣ
	9253713000			stroke 64/66 mm push rod Length 285mm ports2XM16X1.5
	FA1024A			
	FA1025A	24/30		ΦΥΣΟΥΝΑ ΔΙΠΛΗΣ ΕΝΕΡΓΕΙΑΣ ΑΞΟΝΑ
				DALICAS 2 ΖΩΣΤΗΡΕΣ
	35304801330	30/30		ΦΥΣΟΥΝΑ ΔΙΠΛΗΣ ΕΝΕΡΓΕΙΑΣ ΑΞΟΝΑ
	RL3530SB10			DALICAS 2 ΖΩΣΤΗΡΕΣ
	35304801330			stroke 64/64 mm push rod Length 270mm ports2XM16X1.5













EIKONA	ΚΩΔΙΚΟΣ	CAST	CONTROL	SPLINE	L1	BUSHDIA	BUSHDIA
	256012631187	2752	1	26	145	14	MAN
	72578/2752						815061042194
	72989 79227 72578						81506106216 815061043194
	992012631007	3070	1	26	215	14	MAN
	72508 72985 79223						815061032188 81506106078
							81506106128
	991012631007	3071					MAN
	72509 79224 72986						815061033187 81506106077
							81506106129
	220012631037	3162	1	26	130	14	MAN
	72456 72810 79220						D-C
	72982						EVOBUS
	219012631037	3163					3574201438
	72455 72809 79219						MAN D-C EVOBUS
							3574201338
	220022633397	3162	2	26	145	14	MAN
	3162/79210 haldex						81506106213
	79210 72320 72320						D-C
	72970						NEOPLAN
	219022633397	3163					D-C
	3163/79211 haldex						NEOPLAN
	79211 72321 70754						MAN
	72971						81506107154
	212022630757	3177	1	26	145	14	MAN
	70867 72308						D-C
	72322 79212 72972						6204200238
	231062631447	3185	6	26	145	14	MAN
	72173 79208/3185						81506106165
	72303 72968 79514						D-C
	3185/79208 haldex						9424201138
	232062631447	3186					MAN
	71174 72969						81506106165
	79209 72304						D-C
							9424201038
	985022633467	3196	2	26	115	14	MAN
	70771 72562 79204						D-C NEOPLAN
	984022633467	3195					MAN
	79203 72561 70772						D-C NEOPLAN
	353012630387	3226	1	26	130	14	MAN
	72515 79202						81506106091 815061038091
							815061039091

EIKONA	ΚΩΔΙΚΟΣ	CAST	CONTROL	SPLINE	L1	BUSHDIA	ΕΦΑΡΜΟΓΗ
	678041033058	4104	4	10	130	16	SCANIA
	72910/4104						311508
	72512 72987 79225						
	988142630757	3523	1	26	130	14	DAF ESXBU1030
							MAN
	72513 72988 79226						81506106223 81506106127
	897012631237	3878	1	26	145	14	D-C MAN
	72617 70953 79206						617 420 04 38
	99012631067						942 420 03 38
	80001C S-ABA						81506106140
	998012631067	3879	1	26	145	14	D-C MAN
	72616 70952 79205						6174200338
	998012631237						9424200238
	80000C S-ABA						815061019177
	495022631507	5015	2	26	145	14	MAN
	80009 80088 80179		S-ABA				D-C
	FA230016						9424200838
	494022631507	5016	2	26	145	14	MAN
	80008 80087 80178		S-ABA				D-C
	FA23015						9424200938
	492012631507	5017	1	26	145	14	MAN
	80001 80085 80164		S-ABA				D-C ACTROS
	FA23014						9424200338
							NEOPLAN
	493012631507	5018	1	26	145	14	MAN
	80000 80085 80176		S-ABA				D-C ACTROS
	FA23013						9424200238
	490012631507	5019	1	26	145	14	MAN
	80181 80093		S-ABA				D-C
	80011 haldex						3834200438
							9454200738
	491012631507	5020	1	26	145	14	MAN
	80180 80092		S-ABA				3834200538
	80010 haldex						9454200838
	491012631507	5020	1	26	145	14	MAN
	783031020055	3860	3	10	145	12.7	D-C
	72153 72783						VOLVO
	70910						1195462
	782031020055	3861	3	10	145	12.7	D-C
	72152 72782						VOLVO
	70909/3861						1195461
	KIT 355176046 76046						
	76046						





EIKONA	ΚΩΔΙΚΟΣ	CAST	CONTROL	SPLINE	L1	BUSH/DIA	ΕΦΑΡΜΟΓΗ
	783022633467	3860	2	26	145	14	D-C 3574200638
	72060						
	782022633467	3861	2	26	145	14	D-C 3574200738
	72061						
	203011930507	3863	1	19	145	14	D-C ZF/NEOPLAN BOVA
	72203 79429						
	204011930507	3864	1	19	145	14	D-C ZF/NEOPLAN 70276100 BOVA
	72204 79430						
	993012630617	3078	1	26	115	14	D-C NEOPLAN
	70706						
	177012630797	3202	1	26	130	14	D-C NEOPLAN 80110802 EVO 3074200338
	70775						
	994012631277	3900	1	26	145	14	D-C 3574200538
	72596						6174200338
	72059 72056/3900						9424200238
	925012630077	4004	1	26	145	14	D-C 6234200538
	72038						
	926012630077	4005	1	26	145	14	D-C 6234200638
	72039						
	995022633397	4018	2	26	145	14	D-C MAN 81506106246
	72063 72235 72594 79572						
	ΙΔΙΟΣ ΜΕ 80008	5016					
	996022633397	4019	2	26	145	14	D-C MAN 81506106247
	72062 72234 72593 79573						
	ΙΔΙΟΣ ΜΕ 80009	5015					
	212012630867	4024	1	26	145	14	D-C 6174200238
	70954						
	KIT 355176046 76046						
	76046						

ΕΙΚΟΝΑ	ΚΩΔΙΚΟΣ	CAST	CONTROL	SPLINE	L1	BUSHDIA	ΕΦΑΡΜΟΓΗ
	923011020707	3049	1	10	165	14	DAF 1311809
	79167						
	924011020707	3050	1	10	165	14	DAF 1311810
	79168						
	231011030837	3185	1	10	143	14	DAF 297173
	72312						.0159563
	72544						
	232011030837	3186	1	10	143	14	DAF .0159564 297172
	72313						
	72544						
	986021023407	3226	2	10	165	14	DAF 0159591 361323
	72540						
	986021031557	3226	2	10	140	14	DAF 1311809
	72202						
	986021021557						.0159565
	72535						284860
	678031021107	4104	3	10	127	14	DAF
	72011						
	678021023397	4104	2	10	140	14	DAF 537538
	72534						
	678021033397						282609
	72197						
	931011020407	4042	1	10	165	14	DAF 159589
	72538						361544
	932011020407	4043	1	10	165	14	DAF 159590
	72539						
							361543
	935101031028	2771	10	10	130	16	SCANIA 362047
	72237 72957						394189
	936101031028	2772	10	10	130	16	SCANIA 362046
	72236 72956						394190 397746

EIKONA	ΚΩΔΙΚΟΣ	CAST	CONTROL	SPLINE	L1	BUSHDIA	ΕΦΑΡΜΟΓΗ
	923011040558	3049	1	10	165	16	SCANIA
	70665						1324357
	79105						219860
	72807						
	924011040558	3050	1	10	165	16	SCANIA
	70664						1324358
	79106						219859
	72808						
	986051043088	3226	5	10	165	16	SCANIA
	72662						1112831
	72467						394419
	981051043088	3662	5	10	165	16	SCANIA
	72624						1112833
	72660						DAF
	72491						ESXBU1005
	980051043088	3663	5	10	165	16	SCANIA
	72625						394182
	72661						DAF
	72492						XBU1001
	979011040738	3704	1	10	165	16	SCANIA
	72664 72621						276526
							276576
	978011040738	3705	1	10	165	16	SCANIA
	72620 72663						1112829
							276525
							384417
	26911030628	3883	1	10	130	16	SCANIA
	72730						383825
	2680110030628	3884	1	10	130	16	SCANIA
	72729						383826
							394195
	927011041408	4083	1	10	165	16	SCANIA
	72995 79550						1356696
	928011041408	4084					1356695
	72996 79551						
	927011040848	4083	1	10	165	16	SCANIA
	79033						1789567
	79442						
	928011040848	4084		4084			
	79034						







ΕΙΚΟΝΑ	ΚΩΔΙΚΟΣ	CAST	CONTROL	SPLINE	L1	BUSHDIA	ΕΦΑΡΜΟΓΗ
	678041033058	4104	4	10	130	16	SCANIA 311508
	72910						
	351011040848	4040	1	10	165	16	SCANIA 362135
	72825						DAF ESXBU1010
	72630						
	352011040848	4041	1	10	165	16	SCANIA 1112840
	72826						DAF XBU1012
	72631						
	567011030848	4050	1	10	130	16	SCANIA 394194
	72468 72893						
		4051	1	10	130	16	SCANIA 380253
	72469						
	986051021755	3226	5	10	140	12,7	VOLVO 8196083
	79161 79428						
	353031020555	3226	3	10	125	12,7	VOLVO 3177014
	79464						
	782031020055	3861	3	10	145	12,7	VOLVO 1136432
	72782						
	70909 72723						
	783031020055	3860	3	10	145	12,7	VOLVO 1195462
	72783						
	70910 72924						
	783031020055	3860	3	10	145	12,7	VOLVO
	678031021505	4104	3	10	140	12,7	VOLVO 1135004
	70902						
	72667						
	72027						
	678041021725	4104	4	10	140	12,7	VOLVO 1196321
	72166 72678						BUS-E
	76046						
	355176046						

EIKONA	ΚΩΔΙΚΟΣ	CAST	CONTROL	SPLINE	L1	BUSHDIA	ΕΦΑΡΜΟΓΗ
	997011931007	3878	1	19	145	14	ZF NEOPLAN
	72688						70276010 11013284
	998011931007	3879	1	19	145	14	ZF NEOPLAN
	72689						70276011 11013285
	970031920907	2760	3	19	160	14	KASSBOHRER 82830005520
	72014						
	971031920917	2761	3	19	160	14	KASSBOHRER 82830005530
	72015						
	971031951407	2761	3	19	175	14	KASSBOHRER
	79041						
	79237						
	72369						
	970031951407	2760	3	19	175	14	KASSBOHRER 82850000900
	79040						
	79236						
	72368						
	678031031507	4104	3	10	140		BOVA
	11011						
	256012730157	2752	1	27	150	14	RENAULT
	79011 72099						5000445830
	970012833507	2760	1	28	160	14	RENAULT
	79304 72997						5010260027
	971012833507	2761					
	983012710637	4008	1	27	175	14	RENAULT
	72160 79013						5000789892 5010056685
	982012710637	4009	1	27	175	14	RENAULT
	72161						5010260379
	972013721007	2752	1	37	210	14	FRUEHAUF
	70959						
							

ΕΙΚΟΝΑ	ΚΩΔΙΚΟΣ	CAST	CONTROL	SPLINE	L1	BUSHDIA	ΕΦΑΡΜΟΓΗ
	999111021307	4076	11	10	250	14	SAE/SAF
	79149 79331 79005						
	999033731107	4076	3	37	250		KASBOHRER 8238000415
	72758						
	888111011307	4032	11	10	250	14	SAF 3434350800
	72948						4175008501 4175024000
	972011020207	2752	1	10	210	14	SAF/BPW 4175023100
	79502						
	499011011207		1	10	120	14	BRW 4076616250
	05.174.82.213						

MANUAL SLACK ADJUSTERS

ΡΕΓΟΥΛΑΤΟΡΟΙ ΑΠΛΟΙ

ΕΙΚΟΝΑ	ΚΩΔΙΚΟΣ	CAST	CONTROL	SPLINE	L1	BUSHDIA	ΕΦΑΡΜΟΓΗ
	6050011067			1.5'-10	120	14	BRW 05.174.54.70.0
	016131-00			26	145	14	M/S 363 420 00 38
	6075612617			26	145	14	D-C 346 420 1838
	3464201838 6225622617						
	685612617			26	145	14	D-C 3464201738
	3464201738 6225612617						
	2100212702						L ΕΜΠ,
	2100212703						R ΟΠ.
	60443811025		1.5'-10	6,5'	5.5'	0.5'	RH VOLVO 1505325
	295407						
	60443821025				1.5'-10	6,5'	5.5'
	295408						



1

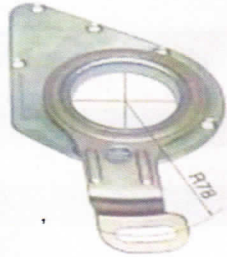

2



3



4



5



6



7



8

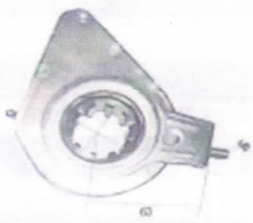

9

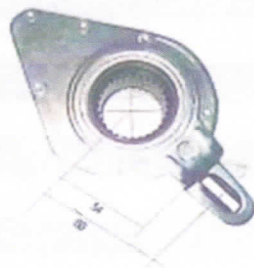

10



11



12

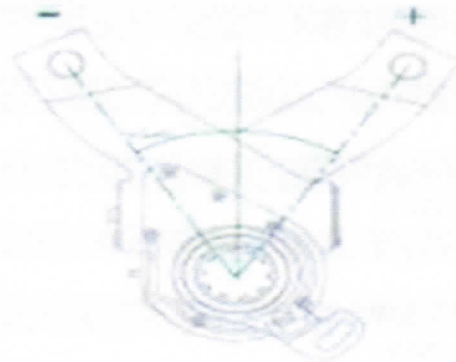
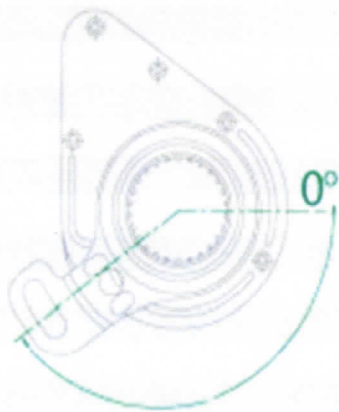

ΕΙΚΟΝΑ	ΚΩΔΙΚΟΣ	ΕΦΑΡΜΟΓΗ	ΠΕΡΙΓΡΑΦΗ
	334026031-1	AMERICAN TRAILER	port:M16X1,5 ΚΟΚΚΙΝΗ ΑΠΛΗ ΜΕ ΦΑΡΔΥ ΛΑΣΤΟΙΧΟ
	334025011-1		port:M22X1,5 ΚΙΤΡΙΝΗ ΑΠΛΗ ΦΑΡΔΥ ΛΑΣΤΟΙΧΟ
	334025031-1	AMERICAN TRAILER	port:M16X1,5 ΚΙΤΡΙΝΗ ΑΠΛΗ ΦΑΡΔΥ ΛΑΣΤΟΙΧΟ
	RL3521AG		port:M22X1,5 ΚΙΤΡΙΝΗ ΑΠΛΗ ΦΑΡΔΥ ΛΑΣΤΟΙΧΟ
	334026011-1		port:M16X1,5 ΚΟΚΚΙΝΗ ΑΠΛΗ
	452 200 001 0		port:M22X1,5 ΚΟΚΚΙΝΗ ΑΠΛΗ
	452 200 011 0		port:M16X1,5 ΚΙΤΡΙΝΗ ΑΠΛΗ
	DS-8207-F		port:M22X1,5 ΚΙΤΡΙΝΗ ΑΠΛΗ
	452 200 002 0		port:M16X1,5 ΚΟΚΚΙΝΗ ΑΠΛΗ
	DS-8207-H		port:M22X1,5 ΚΟΚΚΙΝΗ ΑΠΛΗ
	452 200 012 0		port:M16X1,5 ΚΟΚΚΙΝΗ ΑΥΤΟΜΑΤΗ
	35210040020		ports:M22X1,5 ΚΟΚΚΙΝΗ ΑΥΤΟΜΑΤΗ
	4522002210 (9522002210)		ports:M16X1,5 ΚΟΚΚΙΝΗ ΑΥΤΟΜΑΤΗ
	RL3521BA-A		ports:M22X1,5 ΚΟΚΚΙΝΗ ΑΥΤΟΜΑΤΗ
	35210040010		ports:M16X1,5 ΚΟΚΚΙΝΗ ΑΥΤΟΜΑΤΗ
	9522000370-1		ports:M22X1,5 ΚΟΚΚΙΝΗ ΑΥΤΟΜΑΤΗ
	DS-8207-F		port:M16X1,5
	452 000 222 0		ports:M22X1,5 ΚΙΤΡΙΝΗ ΑΥΤΟΜΑΤΗ
	RL3521BC		ports:M16X1,5 ΚΟΚΚΙΝΗ ΑΥΤΟΜΑΤΗ
	RL3521BC-A		ports:M22X1,5 ΚΟΚΚΙΝΗ ΑΥΤΟΜΑΤΗ
	9522000340		ports:M16X1,5 ΚΟΚΚΙΝΗ ΑΥΤΟΜΑΤΗ
	DS-8207-H		ports:M22X1,5 ΚΟΚΚΙΝΗ ΑΥΤΟΜΑΤΗ
	9522010020		ports: M16X1,5ΘΥΛ.:M24X1,5 ΑΡΣ., ΚΟΚΚΙΝΗ ΑΥΤΟΜΑΤΗ
	RL3521EA01		ports:M16X1,5 ΔΙΠΛΗ
	9522010010-1		ports:M16X1,5 ΔΙΠΛΗ
	RL3521EA02		ports:M16X1,5 ΔΙΠΛΗ
	4528040120-1	DALICA	ports:M22X1,5 ΕΞΟΤ. ΣΠΕΙΡ. ports:M16X1,5 ΕΣΩΤ. ΣΠΕΙΡ
	RL3521CB		
	4528020070 (4528020090)	ΔΙΠΛΗ ΑΥΤΟΚΙΝΗΤΟΥ	ports:M22X1,5 ΕΞΟΤ. ΣΠΕΙΡ. ports:M16X1,5 ΕΣΩΤ. ΣΠΕΙΡ
	RL3521CA		
	4528020000	SCANIA	ports:M22X1,5 ΕΞΟΤ. ΣΠΕΙΡ. ports:M16X1,5 ΕΣΩΤ. ΣΠΕΙΡ 1/4"
	91300000703		

ΕΙΚΟΝΑ	ΚΩΔΙΚΟΣ	ΕΦΑΡΜΟΓΗ	ΠΕΡΙΓΡΑΦΗ
	334026031-1	AMERICAN TRAILER	port:M16X1,5 ΚΟΚΚΙΝΗ ΑΠΛΗ ΜΕ ΦΑΡΔΥ ΛΑΣΤΟΙΧΟ
	334025011-1		port:M22X1,5 ΚΙΤΡΙΝΗ ΑΠΛΗ ΦΑΡΔΥ ΛΑΣΤΟΙΧΟ
	334025031-1	AMERICAN TRAILER	port:M16X1,5 ΚΙΤΡΙΝΗ ΑΠΛΗ ΦΑΡΔΥ ΛΑΣΤΟΙΧΟ
	RL3521AG		port:M22X1,5 ΚΙΤΡΙΝΗ ΑΠΛΗ ΦΑΡΔΥ ΛΑΣΤΟΙΧΟ
	452 200 001 0		port:M16X1,5 ΚΟΚΚΙΝΗ ΑΠΛΗ
	452 200 011 0 DS-8207-F		port:M22X1,5 ΚΟΚΚΙΝΗ ΑΠΛΗ
	452 200 002 0		port:M16X1,5 ΚΙΤΡΙΝΗ ΑΠΛΗ
	DS-8207-H 452 200 012 0		port:M22X1,5 ΚΙΤΡΙΝΗ ΑΠΛΗ
	35210040020		port:M16X1,5 ΚΟΚΚΙΝΗ ΑΥΤΟΜΑΤΗ
	4522002210 (9522002210) RL3521BA-A		ports:M22X1,5 ΚΟΚΚΙΝΗ ΑΥΤΟΜΑΤΗ
	452 000 222 0		port:M16X1,5 ports:M22X1,5 ΚΙΤΡΙΝΗ ΑΥΤΟΜΑΤΗ
	RL3521BC RL3521BC-A 9522000340 DS-8207-H		ports:M22X1,5 ΚΙΤΡΙΝΗ ΑΥΤΟΜΑΤΗ
	9522010020		ports: M16X1,5ΘΥΛ.:M24X1,5 ΑΡΣ, ΚΟΚΚΙΝΗ ΑΥΤΟΜΑΤΗ
	RL3521EA01		
	9522010010-1		ports:M16X1,5 ΔΙΠΛΗ
	RL3521EA02		
	4528040120-1	DALICA	ports:M22X1,5 ΕΞΟΤ. ΣΠΕΙΡ. ports:M16X1,5 ΕΣΩΤ. ΣΠΕΙΡ
	RL3521CB		
	4528020070 (4528020090)	ΔΙΠΛΗ ΑΥΤΟΚΙΝΗΤΟΥ	ports:M22X1,5 ΕΞΟΤ. ΣΠΕΙΡ. ports:M16X1,5 ΕΣΩΤ. ΣΠΕΙΡ
	RL3521CA		ports:M22X1,5 ΕΞΟΤ. ΣΠΕΙΡ. ports:M16X1,5 ΕΣΩΤ. ΣΠΕΙΡ 1/4"
	4528020000	SCANIA	ports:M22X1,5 ΕΞΟΤ. ΣΠΕΙΡ. ports:M16X1,5 ΕΣΩΤ. ΣΠΕΙΡ 1/4"
	91300000703		ΕΛΑΣΤΙΚΟ ΧΟΥΦΤΑΣ

ΕΙΚΟΝΑ	ΚΩΔΙΚΟΣ	ΔΙΑΣΤΑΣΗ	ΕΦΑΡΜΟΓΗ	
	147.606-00	7/8" F=118MM	ΜΠΟΥΛΟΝΙ F89 ΚΟΝΤΟ D	
	147.608-00	7/8" F=130MM	ΜΠΟΥΛΟΝΙ F89 ΜΕΣΑΙΟ D	
	147.610-00	7/8" F=142MM	ΜΠΟΥΛΟΝΙ VOLVO D	
	147.612-00	1573081	7/8" F=96MM	ΜΠΟΥΛΟΝΙ VOLVO D
	147.614-00	1573082	7/8" F=106MM	ΜΠΟΥΛΟΝΙ VOLVO D
	147.001-00	1589009	7/8" F=116MM	ΜΠΟΥΛΟΝΙ VOLVO D

ΠΑΞΙΜΑΔΙΑ VOLVO

ΕΙΚΟΝΑ	ΚΩΔΙΚΟΣ	ΔΙΑΣΤΑΣΗ	ΠΕΡΙΓΡΑΦΗ	
	147.623-00	943402	7/8" SW28	ΠΑΞΙΜΑΔΙ ΚΟΝΤΡΑ VOLVO
	147.620-00	21668	3/4" SW34	ΠΑΞΙΜΑΔΙ ΕΞΩΤΕΡΙΚΟ VOLVO
	147.621-00	1083894	7/8"SW34	ΠΑΞΙΜΑΔΙ ΕΞΩΤ.ΠΕΤΑΛ.VOLVO

ΜΠΟΥΛΟΝΙΑ SCANIA

ΕΙΚΟΝΑ	ΚΩΔΙΚΟΣ	ΔΙΑΣΤΑΣΗ	ΠΕΡΙΓΡΑΦΗ	
	127.501-00	0 123 250	F=86mm	ΜΠΟΥΛΟΝΙ SCANIA R ΕΜΠΡ.
	127.502-00	0 123 249	F=86mm	ΜΠΟΥΛΟΝΙ SCANIA L ΕΜΠ.
	127.508-00		7/8" F=92mm	ΜΠΟΥΛΟΝΙ SCANIA R ΟΠΙΣΘΙΟ
	127.507-00		7/8" F=92mm	ΜΠΟΥΛΟΝΙ SCANIA L ΕΜΠΡ.
	127.503-00	132602	7/8" F=102mm	ΜΠΟΥΛΟΝΙ SCANIA R ΟΠΙΣΘΙΟ
	127.504-00	0 132 601	7/8" F=102mm	ΜΠΟΥΛΟΝΙ SCANIA L ΟΠΙΣΘΙΟ
	127.511-00	290062	7/8" F=80mm	ΜΠΟΥΛΟΝΙ SCANIA N.T.D
	127.512-00	1368693	7/8" F=97mm	ΜΠΟΥΛΟΝΙ SCANIA N.T.D
	127.510-00	1368694	7/8" F=102mm	ΜΠΟΥΛΟΝΙ SCANIA N.T.D
	127.513-00		7/8" F=124mm	ΜΠΟΥΛΟΝΙ SCANIA N.T.D

ΠΑΞΙΜΑΔΙΑ SCANIA

ΕΙΚΟΝΑ	ΚΩΔΙΚΟΣ	ΔΙΑΣΤΑΣΗ	ΠΕΡΙΓΡΑΦΗ	ΕΙΚΟΝΑ
	127.062-00	0 121 306	7/8 SW33	ΠΑΞΙΜΑΔΙ SCANIA R ΕΣΩΤΕΡΙΚΟ
	127.063-00	0 121 305	7/8 SW33	ΠΑΞΙΜΑΔΙ SCANIA L ΕΣΩΤΕΡΙΚΟ
	127.060-00	0 120 913	7/8 SW33	ΠΑΞΙΜΑΔΙ SCANIA R ΕΞΩΤΕΡΙΚΟ
	127.061-00	0 120 912	7/8 SW33	ΠΑΞΙΜΑΔΙ SCANIA L ΕΞΩΤΕΡΙΚΟ
	127.065-00	0 243 955		ΠΑΞΙΜΑΔΙ SCANIA L ΠΕΤΑΛ.
	127.065-00	0 243 955	7/8 SW33	ΠΑΞΙΜΑΔΙ SCANIA R ΜΕ ΦΟΥΡΟ
	127.062-00	0 121 306	7/8 SW33	ΠΑΞΙΜΑΔΙ SCANIA R ΕΣΩΤΕΡΙΚΟ

ΜΠΟΥΛΟΝΙΑ DALICAS

ΕΙΚΟΝΑ	ΚΩΔΙΚΟΣ	ΔΙΑΣΤΑΣΗ	ΠΕΡΙΓΡΑΦΗ	ΕΙΚΟΝΑ
	047.002-00		A20X1.5 B20X1.5C88mm	
	047.024-00	03.296.23.05.0	A20X1.5 B20X1.5C100Pilot	BRW
	047.008-00	03.296.12.04.0	A20X1.5 B20X1.5C95mm	BRW
	047.016-00	03.296.13.07.0	A22X2 B20X2 C106mm	BRW KASSBOHRER
	047.045-00	03.296.23.15.0	A22X1.5 B22X2 C96mm	BRW
	047.039-00	03.296.23.17.0	A22X1.5 B22X2C112mm	BRW KASSBOHRER

ΠΑΞΙΜΑΔΙΑ DALICAS

ΕΙΚΟΝΑ	ΚΩΔΙΚΟΣ	ΔΙΑΣΤΑΣΗ	ΠΕΡΙΓΡΑΦΗ	ΕΙΚΟΝΑ
	047.103-00	02.5270.72.00	22X2	ΠΑΞΙΜΑΔΙ BRW DALICAS ΚΩΝΟ

ΕΙΚΟΝΑ	ΚΩΔΙΚΟΣ	ΔΙΑΣΤΑΣΗ	ΕΦΑΡΜΟΓΗ
	017.002-00	M14X1,5X57	M/S EM.309 401 0271
	017.004-00	M14X1,5X64	M/S ΟΠ.3094020271
	017.013-00	M14X1,5X68	M/S EM.3144010071
	017.010-00	M18X1,5X73	M/S ΟΠ.318 402 0071
	017.137-00	M18X1,5X84	ATEGO 674 402 0171
	017.086-00	M20X1,5X81	M/S 3124021071
	017.039-00	M20X1,5X92	M/S3274020271
	017.027-00	M20X1,5X98	M/S327 402 0371
	017.146-00	M22X1,5X78	M/S 942 401 0271
	017.144-00	M22X1,5X85	M/S 000 401 0672
	017.064-00	M22X1,5X91	M/S 942 401 0271
	017.060-00	M22X1,51X97	M/S 7701351087
	017.148-00	M22X1,5X91/101,5 / 57	M/S 440205
	017.071-00	M22X1,5X108	M/S 498 401 0071
	017.072-00	M22X1,5X115	M/S 381 401 06 71
	017.058-00	M22X1,5X105	M/S 381 401 07 71 S1
	017.066-00	M22X1,5X125	RENAULT 7701352245
	017.091-00	M22X1,5X135	M/S381 401 13 71
467.000-00	M22X1,5X102	NEOPLAN	

ΠΑΞΙΜΑΔΙΑ

ΕΙΚΟΝΑ	ΚΩΔΙΚΟΣ	ΔΙΑΣΤΑΣΗ	ΕΦΑΡΜΟΓΗ
	017.109-00	M14X1,5 SW20	M/S
	017.110-00	M18X1,5 SW24	M/S 074361018201
	017.111-00	M20X1,5 SW20	M/S 074361 020204
	017.112-00	M22X1,5 SW20	M/S 912003
	017.113-00	M22X1,5 SW30	M/S 912003

ΠΑΞΙΜΑΔΙΑ ΜΕ ΦΟΥΡΟ

ΕΙΚΟΝΑ	ΚΩΔΙΚΟΣ	ΔΙΑΣΤΑΣΗ	ΕΦΑΡΜΟΓΗ
	077.047-10	M18X1,5 SW27	M/S ΠΕΤΑΛΟΥΔΑ
	077.048-00	M20X1,5 SW27	M/S ΠΕΤΑΛΟΥΔΑ
	017.115-00	M22X1,5 SW32	M/S ΠΕΤΑΛΟΥΔΑ

ΚΟΝΟΙ

	017.006-00	14MM	M/S 319 402 00 75
	017.012-00	18MM	M/S 324 997 0026
	017.021-00	20MM	M/S 0664020075
	017.033-00	22MM	M/S 3174020175

ΓΚΡΟΒΕΡ



ΕΙΚΟΝΑ	ΚΩΔΙΚΟΣ	ΔΙΑΣΤΑΣΗ	ΕΦΑΡΜΟΓΗ
	077.020-00	14MM	M/S 074361 014351
	017.105-00	18MM	M/S 074361 018352
	077.023-00	20MM	BRW 02.5615.20.90
	077.024-00	22MM	BRW 02.5615.22.90















ΜΠΟΥΛΟΝΙΑ DAF





ΕΙΚΟΝΑ	ΚΩΔΙΚΟΣ	ΔΙΑΣΤΑΣΗ	ΕΦΑΡΜΟΓΗ
	107.000-00	M22X1,5X114	099 717
	107.002-00	M22X1,5X95	099 730
	107.004-00	M22X2X84	0 099 730
	107.014-00	M22X2X102	
	107.015-00	M22X2X118	217 266
	107.016-00	M22X2X120	0259 931
	107.036-00	M22X1,5X114	620648

ΕΙΚΟΝΑ	ΚΩΔΙΚΟΣ	ΔΙΑΣΤΑΣΗ	ΕΦΑΡΜΟΓΗ	
	016.260-00	673 993 0410	4.1X30X97	ΕΛΑΤΗΡΙΟ ΣΙΑΓΩΝΩΝ M/S
	016.261-00	673 993 0310	4.0X25X66.2	ΕΛΑΤΗΡΙΟ ΣΙΑΓΩΝΩΝ M/S 814
	016.203-00	617 993 0610	4.0X26X246	ΕΛΑΤΗΡΙΟ ΣΙΑΓΩΝΩΝ M/S EYROPA
	016.204-00	346 993 0310	4.0X26X237	ΕΛΑΤΗΡΙΟ ΣΙΑΓΩΝΩΝ M/S EYROPA
	016.220-00	346 993 0180	4.2X31X229	ΕΛΑΤΗΡΙΟ ΣΙΑΓΩΝΩΝ M/S EYROPA
	016.210-00	317 993 1010	4.5X36X205	ΕΛΑΤΗΡΙΟ ΣΙΑΓΩΝΩΝ M/S 302
	016.214-00	352 421 0192	5.3X37X253	ΕΛΑΤΗΡΙΟ ΣΙΑΓΩΝΩΝ M/S N.T
	016.227-00	314 993 1110	4.0X23X282	ΕΛΑΤΗΡΙΟ ΣΙΑΓΩΝΩΝ M/S N.T
	016.228-00	309 993 0510	4.6X28X235	ΕΛΑΤΗΡΙΟ ΣΙΑΓΩΝΩΝ M/S N.T
	016.208-00	302 993 0610	5.0X33X245	ΕΛΑΤΗΡΙΟ ΣΙΑΓΩΝΩΝ M/S N.T ΜΟΝΟΠΑΤΟ
	016.205-00	360 993 0110	5.0X31X255	ΕΛΑΤΗΡΙΟ ΣΙΑΓΩΝΩΝ M/S N.T
	016.212-00	314 993 0810	4.0X22X193	ΕΛΑΤΗΡΙΟ ΣΙΑΓΩΝΩΝ M/S N.T

ΕΛΑΤΗΡΙΑ ΣΙΑΓΩΝΩΝ DAF

ΕΙΚΟΝΑ	ΚΩΔΙΚΟΣ	ΔΙΑΣΤΑΣΗ	ΕΦΑΡΜΟΓΗ	
	106.009-00		4.4X28X226	ΕΛΑΤΗΡΙΟ ΣΙΑΓΩΝΩΝ
	106.068-00		5.3X38 5X155	ΕΛΑΤΗΡΙΟ ΣΙΑΓΩΝΩΝ DAF95-BOVA





ΕΙΚΟΝΑ	ΚΩΔΙΚΟΣ	ΔΙΑΣΤΑΣΗ	ΕΦΑΡΜΟΓΗ	
	046.014-00		4.0 X22X156	DALICAS ΤΖΟΥΜΠΟ ΚΟΝΤΟ
	046.197-00	03.397.35.01.0	3.6x22x163	DALICAS ΤΖΟΥΜΠΟ ΜΑΚΡΥ
	046.015-00	03.397.34.11.0	3.2X21X180	DALICAS ΜΕ ΘΗΛΙΑ
	046.196-00	539746070	4.0X25262	ΣΙΑΓΩΝΩΝ DALICAS-SCANIA N.T
	046.011-00	05.397.46.03.0	4.5X24X265	ΕΛΑΤΗΡΙΟ ΣΙΑΓΩΝΩΝ ΕΝΙΣΧΥΜΕΝΟ
	406.096-00		4.0X21X105	ΕΛΑΤΗΡΙΟ ΣΙΑΓΩΝΩΝ N.T
	046.000-00	05.397.26.03.0	2,8X26X148	ΕΞΩΤΕΡΙΚΟ ΦΥΣΟΥΝΑΣ ΚΟΝΤΟ
	046.002-00	539726020	3.2X25X225	ΕΞΩΤΕΡΙΚΟ ΦΥΣΟΥΝΑΣ ΜΑΚΡΥ
	126.010-00	120824	4.5X28X98	ΕΛΑΤΗΡΙΟ SCANIA
	126.072-00	1305055	4.8X25X260	ΕΛΑΤΗΡΙΟ SCANIA
	146.005-00	1586683	6X37.5X204	ΕΛΑΤΗΡΙΟ VOLVO F88-F89
	146.019-00	3464992	5,5X46X202	ΕΛΑΤΗΡΙΟ VOLVO F12 INTERCOOLER
	016.115-00	3954200041		ΣΕΤ ΣΙΑΓΩΝΩΝ EUROPA (ΠΕΙΡΟΙ)
	016.110-00	3819940009		ΑΣΦΑΛΕΙΑ ΠΕΙΡΟΥ ΣΙΑΓΩΝΟΣ ΚΟΝΤΗ
	016.111-00	9429940009		ΑΣΦΑΛΕΙΑ ΠΕΙΡΟΥ ΣΙΑΓΩΝΟΣ ΜΑΚΡΙΑ









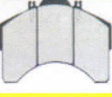

ΕΙΚΟΝΑ	ΚΩΔΙΚΟΣ	ΕΦΑΡΜΟΓΗ	ΔΙΑΣΤΑΣΗ	ΠΕΡΙΓΡΑΦΗ
	03.3131.2201-3	M/S 002 430 21 01		ΑΝΤΛΙΑ ΦΡΕΝΩΝ Μ.ΕΝΕΡΓΕΙΑΣ
	RCCM0008.1			1.1/4"
	H38721.04 (S5249)			
	RCCM2790.0	M/S 002 430 14 01		ΑΝΤΛΙΑ ΦΡΕΝΩΝ Μ.ΕΝ.
	03.3134-0300.3			1.3/8"
	H34703.0.0 (S406)			
	206-34700/1 5462984			ΑΝΤΛΙΑ ΦΡΕΝΩΝ Μ.ΕΝ. 1,1/2"
	RCCD0113.0	M/S 0024308301	1.1/4	ΑΝΤΛΙΑ ΦΡΕΝΩΝ ΔΙΠ.ΕΝ
	H31927.0.2 (S5231)			1.1/4
	RCCD0114.0		1.1/2"	ΑΝΤΛΙΑ ΦΡΕΝΩΝ ΔΙΠ.ΕΝ
	H38944,0.2 (S5154)			
	AG1605C1	M/S 318 295 00 06	17MM	ΑΝΤΛΙΑ ΦΡΕΝΩΝ ΔΙΠ.ΕΝ(ΚΑΜΠΙΝΑΣ)
	H17853.1.1 S5207			
	RCRS 1813.5			ΔΟΧΕΙΟ ΑΝΤΛΙΑΣ ΥΓΡΟΥ ΜΕΓΑΛΟ
	RCRS 1257.9			ΔΟΧΕΙΟ ΑΝΤΛΙΑΣ ΥΓΡΟΥ ΜΙΚΡΟ

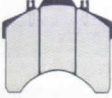

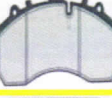
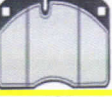

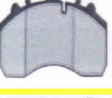

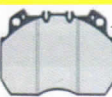
CLUTCH CYLINDER

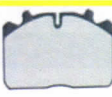
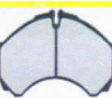
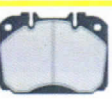
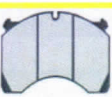
ΑΝΤΛΙΕΣ ΑΜΠΡΑΓΙΑΣ

ΕΙΚΟΝΑ	ΚΩΔΙΚΟΣ	ΕΦΑΡΜΟΓΗ	ΔΙΑΣΤΑΣΗ	ΠΕΡΙΓΡΑΦΗ
	LYYB01-071-BZ			ΑΝΤΛΙΑ ΑΜΠΡΑΓΙΑΣ Μ/S
	KG 19055.1.		19.05MM	ΑΝΤΛ.ΜΠΡΑΓΙΑΣ ΑΝΩ Μ/S 406-410
	51720 (S55160)			
	000 295 91 06			
	KG19046.1.1	M/S 0002955006		ΑΝΤΛ. ΑΜΠΡΑΓΙΑΣ ΑΝΩ Μ/S 608
	RCCE0004.1		19.05MM	
	RCCE0012.2	M/S 0012955906	19.05MM	ΑΝΤΛΙΑ ΑΜΠΡΑΓΙΑΣ ΑΝΩ Μ/S 814
	KG 190072.01			
	RCCE0036.1	M/S 001 295 72 06	20.64MM	ΑΝΤΛΙΑ ΑΜΠΡΑΓΙΑΣ ΑΝΩ Μ/S 814
	RCCE0003.3		28,00MM	ΑΝΤΛΙΑ ΑΜΠΡΑΓΙΑΣ ΚΑΤΩ Μ/S 608
	KG 20001.0.8	M/S 0012959106	20.64MM	ΑΝΤΛΙΑ ΑΜΠΡ. ΑΝΩ Μ/S ΑΤΕΓΟ
	KG 22019.1.1	M/S 001 295 74 06	20.20MM	ΑΝΤΛΙΑ ΑΜΠΡΑΓΙΑΣ ΑΝΩ Μ/S 814
	S5372	DAF 1278342		
	RCCE0023.8	M/S 000 295 68 06	23.81MM	ΑΝΤΛΙΑ ΑΜΠΡΑΓΙΑΣ ΑΝΩ Μ/S 1932
	KG2395.1.7	MAN .01100.6883		
	(S5185)			
	2423.0603.3		23MM	ΑΝΤΛΙΑ ΑΜΠΡΑΓΙΑΣ ΑΝΩ Μ/S 1932
	AG1605 63	VOLVO 1 628 218		ΑΝΤΛΙΑ ΑΜΠΡΑΓΙΑΣ VOLVO F 12
	KG28012.0.1			
	(S5547)			
	AG1605 61	VOLVO 1 581 209	28.57MM	ΑΝΤΛΙΑ ΑΜΠΡΑΓΙΑΣ VOLVO F 12
	KG28014.1.1	1669488		
	(S5269)			
	AG1605 62	DAF 1291190	22.20MM	ΑΝΤΛΙΑ ΑΜΠΡΑΓΙΑΣ ΑΝΩ
	KG22026.0.1			
	(S5505)			
	KG250004.0.2	SCA 1105 332	25.40MM	ΑΝΤΛΙΑ ΑΜΠΡΑΓΙΑΣ ΚΑΤΩ Μ/S 1932
	AG1605 F	1 105 332-9		
	624503 (S5524)			
	AG 1605 B2	M/S 00295 7907	38.10MM	ΑΝΤΛΙΑ ΑΜΠΡΑΓΙΑΣ ΚΑΤΩ Μ/S 1932
	KN3805J1 (S 6197)	001 295 03 07		
	03.2538-0104.3	001 295 53 07	22.20MM	ΑΝΤΛΙΑ ΑΜΠΡΑΓΙΑΣ ΑΝΩ SCANIA

ΕΙΚΟΝΑ	ΚΩΔΙΚΟΣ	ΕΦΑΡΜΟΓΗ	ΔΙΑΣΤΑΣΗ	ΠΕΡΙΓΡΑΦΗ
	RCCR0002.3	M/S 005 420 78 18	7/8" 22.2MM	ΚΥΛΙΝΔΡΑΚΙΑ ΦΡΕΝΩΝ
	03.3222-7802.3			
	R 22050		/8' 22.2MM	ΚΥΛΙΝΔΡΑΚΙΑ ΦΡΕΝΩΝ M/S 410
	RCCR0016.3		15/16"	
	RCCR2322.8		1.5/8"	ΠΑΛΙΑ ΓΕΝΙΑ
	RCCR2423.2			
	RCCR2324.1		1.3/4" 128MM	
	RCCR2422.4		1.3/4" 138MM	ΠΑΛΙΑ ΓΕΝΙΑ
	RCCR2424.0	M/S 0034208018 3454207518	2"	ΠΑΛΙΑ ΓΕΝΙΑ
		03.3241.1802-3	M/S 316 420 01 18	1.5/8" 41.27MM
20131		316 420 02 18		ΧΩΡΙΣ ΠΥΡΟ ΑΣΦΑΛΕΙΑΣ
S6092				
R 4196B1				
RCCR093.7				
R44014A1			1 3/4"	
3250-14013				
03.3250.1401-3 ATE			2"	
R 5098A1				
		LWM043	M/S 000 296 01 07	24/34
	LWMO83	006 420 15 18		
	AG1605C2	007 420 21 18		
	N24802C1			
	S6284			

ΕΙΚΟΝΑ	ΚΩΔΙΚΟΣ				
	20784	75	18	149	M/S 206-409
	29011	125	25	241	IVECO Eurocargo 170E Eurotech mt400 E
	29015	112	20	258	KASSBOHRER SETRA 200 SEIRA
	29032	110	25	206	IVECO Eurocargo 120E14 320E22
	29017	87	23	191	DAF 44 FA-180-600-999 IVECO
	29055	83	22	176	MAN 1999 9 150-8-9 224
	29059 29087-29202 CVP020K	107	30	247	M/S - BPW DAF- SCANIA KASSBOHRER-BOVA
	29067 29302	78	22	176	IVECO VOLVO
	29077 29092 CVP022	106	27	204	DAF 55 FA55,150 B12
	29084	118.3	30	250	M/S
	29087-29059 29202 CVP020K	107	30	247	M/S - BPW-SAF DAF-SCANIA KASSBOHRER-BOVA
	29088	85.6	26	176	DAF-IVECO MAN RENAULT VOLVO
	29090	114	28	249	
	29091	85.6	27	175.6	MAN
	29095 29177 CVP036K	92	30	210	M/S-DAF-MAN BPW-M/S SAF
	29121 CVP026	68	20	125	IVECO RENAULT
	29122 SCP025	87	22	175	IVECO Eurocargo 100 E17-95E21+Tector 65
	29124 15224835 CVP024K	100	28	205.5	ROR (MERITOR)

ΚΩΔΙΚΟΣ	WVA	GR	ΠΛΑΤΟΣ	ΠΑΧΟΣ	ΤΑΜΠΟΥΡΟ	ΠΡΙΤΣ	ΕΦΑΡΜΟΓΗ
							
MERCEDES							
MP/29/1	17682	33-34	120	17/11.8	410		EUROPA
MP/30/2	17238	33-39	140	17/11.8	410	8x18	EUROPA
MP/31/2	19494	33-42	160	17/11.8	410	8x18	EUROPA
MP/31/2X	19494		160	18/12,8	410	8x18	EUROPA
MP/31/2XX	19494		160	19/13,8	410	8x18	EUROPA
MP/32/2	19495	33-47	180	17/11.8	410	8x18	EUROPA
MP/32/2XX2	19495		180	19/13,8	410	8x18	EUROPA
MP/36/2	19488		220	17/11.9	410	8x18	EUROPA
MP/36/2XX	19488		220	19/13,9	410	8x18	EUROPA
MB/65/1	17105	33-38	140	15	418	8x16	M/S
MB/66/1	17182	33-40	60	15	418	8x16	M/S
MB/68/1	17928	33-33	120	15	418	8x16	M/S
MB/69-70/1)	15349-15350		70	10	300	10x10	406-408
MB/69-70/1X	15350		70	11	300	10x10	406-408
MB/69-70/1XX	15350		70	12	300	10x10	406-408
MB/71/1	17409	33-35	135	10	300	8x16	608
MB/72-73/1	15580 15582		100	10	300	10x10	608
MB/72-73/1X	15580		100	11	300	10x10	608
MB/72-73/1XX	15580		100	12	300	10x10	608
MB/74-75/1	19580-19579	33-43	160	18/15.5/8	410	8x20	303 ΕΜΠΡ.
MB/76-77/1	19581-19582	33-50	220	18/15.5/8	410	8x22	303 ΟΠΙΣΘ.
MB/80-81/1	15030-15742	33-52	80	8.0	270	5x10	M/S
MB/96/1	17927	33-55	105	11,8/8,4/10,5	304	8x16	709
MB/97/1	17928	33-53	122	11.8/8.4/10.5	304	8x16	814
MB/98-99/1	17749 17950	35-56	130	13.5/11.5/8.5	360	8x16	817-1317
MB/100-101	17350-17973		102	10	300	10x10	M/S
MB/102/1	17929	33-69	135	11.8/8.4/10.5	304	8x16	814-914
MB/104-105/1	19844-19845		160	13.5/11.5/8.5	360	8x16	1117-1517
MB/107/1			87	10	300		
MB/109/1	17288	33-67	105	13,5/10	308	8x16	709
MB/110/2	17280	33-70	122	13,5/10.4/12,2	308	8x16	814
MB/111-112/1	17950-17290	33-72	130	15.5/13.5/10.5	364	8x16	817-1317
MB/113-114/1	19506-19845	33-73	160	15.5/13.5/10.5	364	8x16	1117-1517
MB/115/1		33-63	135	13,5/10,4/12,2	308	8x16	814-817
MB/117-118/1	15062-17975	33-73	122	10	300	10x10	709
MAN • VW • DAF							
ΚΩΔΙΚΟΣ	WVA	GR	ΠΛΑΤΟΣ	ΠΑΧΟΣ	ΤΑΜΠΟΥΡΟ	ΠΡΙΤΣ	ΕΦΑΡΜΟΓΗ
MP/37-38	15187-15823	45-29	96,5	12	325	8x16	MAN-VW-DAF
MP/39-40	17107	16-29	146	12	325	8x16	MAN-VW-DAF
GG/209/1)	15879	45-28	100	16.3/12.8	360	8x16	MAN
GG/217/1	17107		143	16.3/11.5	360	8x16	MAN
DALICAS							
ΚΩΔΙΚΟΣ	WVA	GR	ΠΛΑΤΟΣ	ΠΑΧΟΣ	ΤΑΜΠΟΥΡΟ	ΠΡΙΤΣ	ΕΦΑΡΜΟΓΗ
VL/76-77/1	19560-19561	54-24	203	19.0/12.5	394	10x14	F12 ΟΠΙΣΘ.
VL/70-71/1	17664-17665	54-19	127	19/15.6/12.5	413	10x14	F12 ΤΕΜΠ.
VL/72-73/1	19467-19408	54-23	178	19.0/12.5-15.6	394	10x14	F12ΕΜ.+F8
VL/74-75/1	19560-19561	54-20	152	19.0/12.5-15.6	413	10x14	F12 ΕΜΠΡ.
VL/81-82/1	17999-19800	54-26	254	19.0/12.5-15.6	394	10x14	F12 INTER.
VL/83-84/1		54-28	240	19.0/12.5-15.6	394	10x14	F12INTER.
VL/85/1		54-30	125	17.9/13.5	410	10x12	125
VL/86/1	19941	54-33	150	17.9/13.5	410	10x12	F16 BUS
VL/87/1	19938	54-31	175	17.9/13.5	410	10x12	F12-F16
VL/88/1	19939	54-30	200	17.9/13.5	410	10x12	F12-F16
VK/89/1	19940	54-29	225	17.9/13.5	410	10x12	F12-F16

ΚΩΔΙΚΟΣ	WVA	GR	ΠΛΑΤΟΣ	ΠΑΧΟΣ	ΤΑΜΠΟΥΡΟ	ΠΡΙΤΣ	ΕΦΑΡΜΟΓΗ
							
SCANIA							
SV/26/1	17161	44-11	127	19.0	412	10X12	141-142
SV/8/1	19075	44-13	178	19.0	412	10X12	142-143
SV/27/1	19993	44-14	203	19.0	412	10X12	142-143
SV/34/1		44-12	254	19.0	412	10X12	142-BUS
SV/39/2	17991	44-23	127	19.1	412	10X12	143 NEO
SV/40/2	19931-19932	44-17	178	19.1	412	10X12	143 NEO
SV/41/2	19932	44-20	203	19.1	412	10X12	143 NEO
SV/42/2	19933	44-18	254	19.1	412	10X12	143 NEO

DAF							
ΚΩΔΙΚΟΣ	WVA	GR	ΠΛΑΤΟΣ	ΠΑΧΟΣ	ΤΑΜΠΟΥΡΟ	ΠΡΙΤΣ	ΕΦΑΡΜΟΓΗ
DF/16-17/2	19256-19260	16-21	178	18.2/10.9-18.8/14	419	10X12	3300-3600
DF/20-21/3	19150-19151	16-20	152	18.2/10.9-18.8/14	419	10X12	3300-3600
DF/30-31/1	19617-19618	16-28	203	18.8/14.3-18.2/10	420	10X12	3300-3600
DF/32-33/1	19890-19891	16-22	200	19.2/16.9-18.6-12	420	10X12	3300-3600
DF/34-35/1	19900-19901	16-24	150	19.2/16.9-18.6-12	420	10X12	DAF 95
DF/36-37/1	19888-19889	16-25	175	19.2/16.9-18.6-12	420	10X12	
DF/38-39/1	19915-19914	16-26	240	19.2/16.9-18.6-12	420	10X12	DAF 95
DF/42-43	19024-19031		150	10.7/10-20.8/14	419	10X12	
DF/44-45/1	19011-19010	16-32	150	11.7/14.1-21.5	420	10X12	DAF 95 NEO
DF/46-47/1	19052-19055	16-37	175	10.8/14.1-21.5	420	10X12	DAF 95 NEO
DF/48-49/1	19063-19064	16-34	200	10.8/14.1-21.5	420	10X12	
DF/50-51/1	19069-19070	16-33	240	10.8/14.1-21.5	420	10X12	



DALICAS							
ΚΩΔΙΚΟΣ	WVA	GR	ΠΛΑΤΟΣ	ΠΑΧΟΣ	ΤΑΜΠΟΥΡΟ	ΠΡΙΤΣ	ΕΦΑΡΜΟΓΗ
BC/36/1	19032	17-12	180	18,0/12,5	420	8X20	BRW
BC/36/1X	19032		180	19.0/13.5	420	8X20	BRW
BC/36/1XX	19032		180	20.0/14.5	420	8X20	BRW
BC/37/1	19094	17-14	200	18.0/12.5	420	8X20	BRW
BC/37/1X	19094	17-14	200	18.0/12.5	420	8X20	BRW
BC/37/1XX	19094	17-14	200	18.0/12.5	420	8X20	BRW
BC/100-101	19902	17-78	200	17.4/12.7/10.7	360	8X20	BRW
BC/81/1	19591	17-75	220	18.0/12.6	420	8X20	BRW
BC/90-91/1	19166	17-30	200	20/3/15.8-19.4/9.0	400	8X20	KASSBOHER
SJ/30-31/1	19477-19478		200			8X20	SAF-KASS
SJ/30-31/1X	19477-19478		200			8X20	SAF-KASS
SJ/22-23/1	19515-19516		200	16	300	8X18	SAF
SJ/26-27/1	19892-19893		200	19,60/19/187	355	8X18	SAF-SAUER
SJ/28-29/1	19283-19284		180		420	8X18	SAF
SJ/28-29/1X	19283-19284		180		420	8X18	SAF
SJ/28-29/1XX	19283-19284		180		420	8X18	SAF
IL/66-67/3	19036-19037		178	19.1/16.3	419	10X14	SMB-FRUEHAUF
FU/4-5/3	19370-19369		219	19.1/16.3	419	10X14	TRAILER
YK/8-9/3	19461-19462		210	16,8/14,0	394		YORK
YK/6-7/3	19334-19333		178	15,8/7,3	394		YORK
YK/12/1	19760		210	15	335		YORK
RW/34-35/1	19030-19033		178	22,4/18,1	419		ROR-MERITOR
RW/21-22/1	19908-19909		200	18/12,1/19,2/11,9	350		ROR-MERITOR
RW/28/2	19555		180	20,9/13,8	410		IVECO-ROR ER
RW/29/2	19554		200	20,9/13,8	410		IVECO-ROR ER
FI/100-101	15732-15733	36-21	80	8	325		FIAT-IVECO
RN/100/1			150	18,5	414		RENAULT

ΕΙΚΟΝΑ	ΚΩΔΙΚΟΣ	ΠΙΕΣΗ	ΕΦΑΡΜΟΓΗ	ΠΕΡΙΓΡΑΦΗ
	ZF 7673 955 127	83 Bar	M/S	ΑΝΤΛΙΑ ΜΑΝΤΕΜΕΝΙΑ
			000 466 7101	
	ZF 7673 955 116	100 Bar	000 460 1480	ΑΝΤΛΙΑ ΜΑΝΤΕΜΕΝΙΑ R
			000 460 2480	Fuel feet hole:M26X1.5
				Fuel discharge hole:M18x1.5
	ZF 7673 955 534	120 Bar	001 466 1301	ΑΝΤΛΙΑ ΜΑΝΤΕΜΕΝΙΑ R
			001 466 1301	Fuel feet hole:M26X1.5
			Fuel discharge hole:M16x1.5	
	ZF 7685 955 147	155 Bar		
	ZF 7673 955 554	120 Bar	M/S 813	ΜΕ ΤΡΟΧΑΛΙΑ ΜΑΝΤΕΜΕΝΙΑ

ΑΝΤΛΙΕΣ ΤΙΜΟΝΙΟΥ VOLVO



ΕΙΚΟΝΑ	ΚΩΔΙΚΟΣ	ΠΙΕΣΗ	ΕΦΑΡΜΟΓΗ	ΠΕΡΙΓΡΑΦΗ
	ZF 7673 955 211	120 Bar	158 5013 VOLVO	ΑΝΤΛΙΑ ΤΙΜΟΝΙΟΥ
	ΜΑΝΤΕΜΕΝΙΑ		8001 454 ZF	ΜΑΝΤΕΜΕΝΙΑ
	7673 955 211-1			
	ZF 7673 955 213	120 Bar	1 587 787 VOLVO	
			F12	
	ZF 7673 955 225	135 Bar	1 589 231 VOLVO	
	ΜΑΝΤΕΜΕΝΙΑ		INTERCOOLER	

ΑΝΤΛΙΕΣ ΤΙΜΟΝΙΟΥ SCANIA

ΕΙΚΟΝΑ	ΚΩΔΙΚΟΣ	ΠΙΕΣΗ	ΕΦΑΡΜΟΓΗ	ΠΕΡΙΓΡΑΦΗ
	ZF 7674 955 106		OEM 571 964	
	LUK 542 0013 10		SCANIA 124-164	ΑΝΤΛΙΑ ΤΙΜΟΝΙΟΥ R
			OEM 1457 710	Fuel feet hole:M26X1.5
			1422 417	Fuel discharge hole:M16x1.5
			1333 790	
			571 436	

ΑΝΤΛΙΕΣ ΤΙΜΟΝΙΟΥ DAF

ΕΙΚΟΝΑ	ΚΩΔΙΚΟΣ	ΠΙΕΣΗ	ΕΦΑΡΜΟΓΗ	ΠΕΡΙΓΡΑΦΗ
	ZF 7673 955 207	130 Bar	DAF627402	ΑΝΤΛΙΑ ΤΙΜΟΝΙΟΥ L
	ΜΑΝΤΕΜΕΝΙΑ		2100-3600	Fuel feet hole:M26X1.5
				Fuel discharge hole:M18x1.5
	S/7673 955 217	143 Bar	3300 - 3600	ΑΝΤΛΙΑ ΤΙΜΟΝΙΟΥ L
	SORL			Fuel feet hole:M26X1.5
	ΜΑΝΤΕΜΕΝΙΑ			Fuel discharge hole:ZM16x1.5
	ZF 7672 955 287	140 Bar	OEM 0526 663	ΑΝΤΛΙΑ ΤΙΜΟΝΙΟΥ L
			DAF 52663	Fuel feet hole:M26X1.5
			Fuel discharge hole:M16x1.5	
	ZF 8001 449		0 526 663	
	ΜΑΝΤΕΜΕΝΙΑ			

ΕΙΚΟΝΑ	ΚΩΔΙΚΟΣ	ΠΙΕΣΗ	ΕΦΑΡΜΟΓΗ	ΠΕΡΙΓΡΑΦΗ
	ZF 7685 955 128-1	120 Bar	MAN TGA 1831-41660	ΑΛΟΥΜΙΝΙΟΥ
	LUK 542 0022 10	140 Bar	MAN 81 47101 6121 81 47101 6080 81 47101 6090	ΑΝΤΛΙΑ ΑΛΟΥΜΙΝΙΟΥ INLET M26X1,5 OUTLET M18X1,5
	ZF 7685955102	FREE BAR	MAN90-F2000-19.233	
	LUK 542 0059 10		TGA 81 47101 6122	
	LUK 542 0023 10	150 Bar	81 47101 6137	ΑΝΤΛΙΑ ΤΙΜΟΝΙΟΥ R Fuel feet hole:M26X1.5 Fuel discharge hole:M18x1.5
	S/7685 955 152	150 Bar	MAN 81471016031 81.471.016.102 81.471.016.108	ΑΝΤΛΙΑ ΤΙΜ R ΑΛΟΥΜΙΝΙΟΥ Fuel feet hole:M26X1.5 Fuel discharge hole:M18x1.5
	ZF 7685 955 152	160 Bar	81.471.016.189	ΚΟΝΤΗ ΠΑΡΟΧΗ ΑΛΟΥΜΙΝΙΟΥ
	S/7685 955 153	150 Bar	MAN81.471.61190	ΑΝΤΛΙΑ ΤΙΜ ΑΛΟΥΜΙΝΙΟΥ L Fuel feet hole:M26X1.5 Fuel discharge hole:M18x1.5
	ZF 7685 955 158	160 Bar	MAN	ΑΡ'ΣΤΡΟΦΗ ΑΛΟΥΜΙΝΙΟΥ
	ZF 7674 955 118	130 Bar	MAN	ΜΑΝΤΕΜΕΝΙΑ ΚΟΝΤΗ ΠΑΡΟΧΗ ΤΡΥΠΑ ΚΟΝ ΥΨΟΣ
	ZF 7674 955 145	130 Bar	MAN	
	ZF 7674 955 519	150 Bar	81 47101 6031	ΑΝΤΛΙΑ ΑΛΟΥΜΙΝΙΟΥ L INLET M26X1,5 OUTLET M16X1,5

ΑΝΤΛΙΕΣ ΤΙΜΟΝΙΟΥ Μ/Σ

ΕΙΚΟΝΑ	ΚΩΔΙΚΟΣ	ΠΙΕΣΗ	ΕΦΑΡΜΟΓΗ	ΠΕΡΙΓΡΑΦΗ
	LUK 542 0032 10	100 Bar	M/S 000 460 1480	ΑΝΤΛΙΑ ΤΙΜΟΝΙΟΥ 814+
	ZF 7684 955 105	100 Bar	M/S 81 47101 6137 001 466 1801	
	PPT 4685011	100 Bar	M/S 814 ATEGO	
	LUK 542 0042 10		CITARO UNIMOG 001 460 4480	
	LUK 542 0047 10	160 Bar	M/S ATEGO	
	LH 2112160		001 460 3080 002 460 3980	
	LUK 542 0048 10	160 Bar	M/S ACTROS 001 460 3180 001 460 5280	
	ZF 7684 955 128-1	100 Bar	M/S - MAN	
		16 lt/min		
	ZF 7684 955 198-1	100 Bar	M/S - MAN	ΑΝΤΛΙΑ ΤΙΜΟΝΙΟΥ R Fuel feet hole:M26X1.5 Fuel discharge hole:M16x1.5
	ZF 7684 955 263-1	120 Bar	M/S - MAN	
		16 lt/min		
	ZF 7685 955 129-1	120 Bar	M/S - MAN	
		19 lt/min		
	ZF 7685 955 184-1	150 Bar	M/S - MAN	
	ZF 7685 955 148	160 Bar	M/S MAN	
		18 Lt/min		

STRAIGHT CONECTOR FITTING



REDUCED STRAIGHT FITTINGS



ΣΥΝΔΕΣΜΟΙ ΑΠΛΟΣ ΙΣΙΟΣ			
ΚΩΔΙΚΟΣ		ΔΙΑΜ.	ΤΙΜΗ
EO1083	ΡΣ-003501	4LL	1,45 €
EO1086	ΡΣ-003504	6L	1,50 €
EO1087	ΡΣ-003505	8L	1,69 €
EO1088	ΡΣ-003506	10L	1,91 €
EO1089	ΡΣ-003507	12L	2,32 €
EO1099	ΡΣ-003518	14S	5,10 €
EO1100	ΡΣ-003519	16S	5,23 €
EO1090	ΡΣ-003508	15L	3,45 €
EO1091	ΡΣ-003509	18L	4,94 €
EO1083A	ΡΦ-140015	5LL	3,10 €
F5101	ΡΦ-140013	7L	3,26 €
F5102	ΡΦ-140007	9L	3,38 €
F5103	ΡΦ-140008	11L	3,60 €
F5104	ΡΦ-140014	13L	3,80 €
EO1100	ΡΣ-003519	16S	5,23 €
EO1092	ΡΣ-003510	22L	6,63 €

ΣΥΝΔΕΣΜΟΙ ΣΥΣΤΟΛΙΚΟΙ				
ΚΩΔΙΚΟΣ		ΔΙΑΜ.	ΣΠΕΙΡΩΜΑ	ΤΙΜΗ
EO1105A	ΡΣ-003400	6 LL- 4 LL		3,93 €
EO1105	ΡΣ-003401	8 L-6 L	14X1,5-12X1,5	3,74 €
EO1106	ΡΣ-003402	10 L-6 L	16X1,5-12X1,5	4,06 €
EO1107	ΡΣ-003403	10 L-8 L	16X1,5-14X1,5	4,09 €
EO1107A	ΡΣ-003404	12 L-6 L	18X1,5-12X1,5	4,46 €
EO1108	ΡΣ-003405	12 L-8 L	18X1,5-14X1,5	4,49 €
EO1109	ΡΣ-003406	12 L-10 L	18X1,5-16X1,5	4,01 €
	ΡΣ-003407	15 L-6 L	22X1,5-12X1,5	5,36 €
EO1109A	ΡΣ-003408	15 L-8 L	22X1,5-14X1,5	5,39 €
EO1110	ΡΣ-003409	15 L-10 L	22X1,5-16X1,5	5,46 €
EO1111	ΡΣ-003410	15 L-12 L	22X1,5-18X1,5	5,59 €
EO1111A	ΡΣ-003412	18 L-10 L		7,44 €
EO1112	ΡΣ-003413	18 L-12 L		6,20 €
EO1113	ΡΣ-003414	18 L-15 L		6,93 €
EO1114	ΡΣ-003416	22 L-15 L		11,22 €
EO1115	ΡΣ-003417	22 L-18 L		10,36 €
EO1123	ΡΣ-003430	12 S-10 S		6,33 €
EO1124	ΡΣ-003429	14 S-10 S		10,49 €
EO1125	ΡΣ-003430	14 S-12 S	22X1,5-18X1,5	10,34 €
EO1126	ΡΣ-003431	16 S-12 S		7,48 €
EO1127	ΡΣ-003429	16 S-14 S		10,72 €
EO1129	ΡΣ-003434	20 S-16S		10,46 €

ΣΥΣΤΟΛΙΚΟ ΚΟΡ ΜΕΤΡΙΚΟ ΚΟΜΠΛΕ



ΚΩΔΙΚΟΣ		ΔΙΑΜ	ΤΙΜΗ
EO1420	ΡΣ-005301	8 - 6 L	3,67 €
EO1421	ΡΣ-005302	10 - 6 L	3,78 €
EO1422	ΡΣ-005310	10 - 8 L	4,06 €
EO1423	ΡΣ-005303	12 - 6 L	4,11 €
EO1424	ΡΣ-05311	12 - 8 L	2,65 €
EO1425	ΡΣ-005318	12 - 10 L	2,72 €
EO1426	ΡΣ-005304	15 - 6 L	4,64 €
EO1427	ΡΣ-005312	15 - 8 L	4,69 €
EO1428	ΡΣ-005319	15 - 10 L	3,07 €
EO1429	ΡΣ-005325	15 - 12 L	3,36 €
EO1431	ΡΣ-005331	18 - 15 L	6,68 €

STANDPIPE ADAPTORS FITTINGS



ΚΟΡ ΒΑΣΗΣ			
ΚΩΔΙΚΟΣ	ΣΩΛΗΝΑ	ΒΑΣΗ	ΤΙΜΗ
EO1380	6L	10X1	2,20 €
EO1381	8L	12X1,5	2,32 €
EO1382	10L	14X1,5	2,94 €
EO1382A	10L	16X1,5	13,40 €
EO1383	12L	16X1,5	2,94 €
EO1384	15L	18X1,5	3,60 €
EO1384A	18L	22X1,5	4,26 €
EO1370B	6LL	1/8	3,22 €
EO1370	6L	1/4	1,86 €
EO1371	8L	1/4	2,00 €
EO1371Γ	8LL	1/8	3,50 €
EO1372	10L	1/4	2,26 €
EO1373	12L	3/8	2,82 €
EO1374	15L	1/2	2,50 €

ΣΥΝΔΕΣΜΟΣ ΒΑΣΕΩΣ ΚΩΝΙΚΟΣ



ΚΩΔΙΚΟΣ		ΣΩΛ-ΒΣ	ΤΙΜΗ
EO878	ΡΣ-001801	4 LL-1/8	1,37 €
EO879	ΡΣ-001802	6 LL-1/8	1,33 €
EO880	ΡΣ001803	8 LL-1/8	1,52 €
EO881	ΡΣ-001804	6 L-1/8	1,04 €
EO881A	ΡΣ-001824	6 L-1/4	1,35 €
EO882B	ΡΣ-001825	8 L-1/8	3,52 €
EO882	ΡΣ-001805	8 L-1/4	1,40 €
EO883B	ΡΣ-001828	10 L-1/8	3,62 €
EO883	ΡΣ-001806	10 L-1/4	1,64 €
EO883A	ΡΣ-001829	10 L-3/8	1,89 €
EO883Γ	ΡΣ-001830	10 L-1/2	2,40 €
EO885	ΡΣ-001831	12 L - 1/4	1,91 €
EO884	ΡΣ-001807	12 L - 3/8	1,81 €
EO887A	ΡΣ-001833	15 L - 3/8	5,43 €
EO887	ΡΣ-001808	15 L - 1/2	2,68 €
EO897	ΡΣ-001818	14S-1/2	5,68 €
EO898	ΡΣ-001819	16S-1/2	3,91 €
EO888	ΡΣ-001809	18L-1/2	3,33 €

ΣΥΝΔΕΣΜΟΙ VOLVO-SCANIA

ΚΩΔΙΚΟΣ		ΔΙΑΜΕΤΡΟΣ	ΤΙΜΗ
KT7943	ΡΦ-140001	1\8	4,00 €
EU1621	ΡΦ-140002	3\16	4,58 €
EU1622	ΡΦ-140003	1\4	4,70 €
EU1623	ΡΦ-140004	3\8	7,35 €
EU1624	ΡΦ-140005	1\2	10,00 €
EU1625	ΡΦ-140006	5\8	12,60 €





CUTTING RINGS CR

ΣΥΝΔΕΤΙΚΟΣ ΔΑΚΤ. (ΜΠΙΜΠΙΚΙΑ)

ΚΩΔΙΚΟΣ	ΔΙΑΜ	ΣΩΛ.	ΤΙΜΗ
EO822 ΡΣ-000101	4 LL	4mm	0,22 €
ΡΦ-020051	5 LL	5mm	0,22 €
EO823 ΡΣ-000102	6 LL	6mm	0,22 €
EO825 ΡΣ-000104	6 L	6mm	0,24 €
EO824 ΡΣ-000105	8 LL	8mm	0,24 €
EO827 ΡΣ000106	10 L	10mm	0,27 €
EO828 ΡΣ-000107	12 L	12mm	0,33 €
EO838 ΡΣ-000118	14 S	14mm	0,56 €
EO829 ΡΣ-000108	15 L	15mm	0,43 €
EO839 ΡΣ-000119	16 S	16mm	0,51 €
EO830 ΡΣ-000109	18 L	18mm	0,56 €
EO840 ΡΣ-000120	20 S	20mm	0,74 €



ΜΠΙΜΠΙΚΙΑ ΟΡΕΙΧΑΛΚΙΝΑ

ΚΩΔΙΚΟΣ	ΔΙΑΜ	ΤΙΜΗ
MP316 ΡΦ-090001	1\8	0,23 €
MP317 ΡΦ-090002	3\16	0,27 €
MP318 ΡΦ-090003	1\4	0,35 €
MP319 ΡΦ-090004	5\16	0,37 €
MP320 ΡΦ-090005	3\8	0,44 €
MP321 ΡΦ-090006	7\16	0,46 €
MP322 ΡΦ-090007	1\2	0,61 €
MP322A ΡΦ-090008	4mm	0,23 €
MP323 ΡΦ-090009	6mm	0,33 €
MP324 ΡΦ-090010	8mm	0,37 €
MP325 ΡΦ-090011	10mm	0,46 €
MP326 ΡΦ-090012	12mm	0,58 €
MP327 ΡΦ-090013	16mm	0,86 €
MP324A ΡΦ-090014	9mm	0,55 €
ΡΦ-090000	11mm	0,61 €
MP323A MP323A	5mm	0,47 €



METAL NUT MN

ΠΕΡΙΚΟΧΛΙΟ (ΠΑΞΙΜΑΔΙΑ) 01

ΚΩΔΙΚΟΣ	ΔΙΑΜ	ΣΩΛ.	ΤΙΜΗ
EO800 ΡΣ-000201	4LL	8x1	0,20 €
EO801 ΡΣ-000202	6LL	10x1	0,21 €
EO802 ΡΣ-000203	8LL	12x1	0,22 €
EO803 ΡΣ-000204	6L	12x1,5	0,22 €
EO804 ΡΣ-000205	8L	14x1,5	0,26 €
EO805 ΡΣ-000206	10L	16x1,5	0,29 €
EO806 ΡΣ-000207	12L	18x1,5	0,35 €
EO816 ΡΣ-100218	14s	22x1,5	0,69 €
EO807 ΡΣ-000208	15L	22x1,5	0,62 €
EO817 ΡΣ-000119	16s	24x1,5	0,96 €
EO808 ΡΣ-000209	18L	26x1,5	0,91 €
EO818 ΡΣ-000120	20S	30x2	1,45 €



INSERT for TUBE IT

ΑΝΤΙΣΤΑΣΕΙΣ ΣΩΛΗΝΑΣ ΠΟΛΥΑΜΙΔΙΟΥ

ΚΩΔΙΚΟΣ	ΔΙΑΜ	ΣΩΛΗΝΑ	ΤΙΜΗ
AR328A ΡΦ-080001	2X4mm	4X1mm	0,16 €
AR328 ΡΦ-080002	4X6mm	6X1mm	0,17 €
AR329 ΡΦ-080003	6X8mm	8X1mm	0,24 €
AR329 ΡΦ-080003	6X9mm	9X1,5mm	0,21 €
ΡΦ-080013	7X10mm	10X1,5-3/8mm	0,33 €
AR330 ΡΦ-080004	7,5X10mm	10X1,25mm	0,40 €
AR331 ΡΦ-080005	8X10mm	10X1-11X1,5mm	0,29 €
AR331 ΡΦ-080005	8X11mm	11X1,5mm	0,29 €
AR332 ΡΦ-080006	9X12mm	12X1,5mm	0,30 €
AR332A ΡΦ-080007	10X1mm	14X2mm	0,44 €
AR333 ΡΦ-080009	12X15mm	15X1,5mm	0,49 €
AR334 ΡΦ-080010	4,2mm-1/4	1/4"	0,20 €
AR335 ΡΦ-080011	6,3mm-3/8	3/8"	0,33 €
AR336 ΡΦ-080012	9,5mm-1/2	1/2"	0,46 €
ΡΦ-080015	3mm-3/16		0,25 €
ΡΦ-080009	11,9X5/8m	5/8"	0,49 €
AR333 ΡΦ-080009	12X16mm	16X2mm	0,40 €
AR333 ΡΦ-080016	5X7mm	7X1,5mm	0,25 €
ΡΦ-080014	14X18mm	18X2mm	0,66 €
ΡΦ-080015	3X5mm	5X1mm	0,25 €
RF-080008	11X16mm	16X2,5mm	0,44 €



ΚΥΑΘΙΑ FLEX

ΚΩΔΙΚΟΣ	ΔΙΑΜΕΤΡΟΣ	ΤΙΜΗ
FL349 ΡΠ-310010	10mm	0,14 €
FL350 ΡΠ-310011	11mm	0,14 €
FL350A ΡΠ-310012	12mm	0,16 €
FL351 ΡΠ-310013	13mm	0,16 €
FL-351A ΡΠ-310014	14mm	0,18 €
FL352 ΡΠ-310015	15mm	0,18 €
FL353 ΡΠ-310016	16mm	0,18 €
FL354 ΡΠ-310018	18mm	0,20 €
FL355 ΡΠ-310020	20mm	0,23 €
FL356 ΡΠ-310022	22mm	0,27 €
FL357 ΡΠ-310024	24mm	0,31 €
FL358 ΡΠ-310026	26mm	0,34 €
FL359 ΡΠ-310028	28mm	0,43 €
FL359B ΡΠ-310030	30mm	0,52 €
FL360 ΡΠ-310033	33mm	0,70 €
FL360 ΡΠ-310038	38mm	0,81 €
ΡΠ-310047	47mm	1,88 €
ΡΠ-310051	51mm	1,83 €
ΡΠ-310057	57mm	1,93 €
ΡΠ-310066	66mm	5,53 €
ΡΠ-310076	76mm	5,89 €



ΜΑΣΤΟΙ ΒΑΣΗΣ ΜΕΤΡΙΚΟ

ΚΩΔΙΚΟΣ	ΣΩΛΗΝΑ	ΣΠΕΙΡ.	ΤΙΜΗ
EO902A	ΡΣ-000404	6L 10X1	1,04 €
EO903A	ΡΣ-000430	6L 12X1,5	1,94 €
EO903B	ΡΣ-000436	6L 22X1,5	2,57 €
EO903Γ	ΡΣ-000440	6L 16X1,5	2,49 €
EO902B	ΡΣ-000603	8LL 10X1	3,37 €
EO904Γ	ΡΣ-000437	8L 22X1,5	2,68 €
EO904E	ΡΣ-000641	8L 10X1	4,28 €
EO904	ΡΣ-000405	8L 12X1,5	1,22 €
EO904Δ	ΡΣ-000431	8L 14X1,5	2,26 €
EO904B	ΡΣ-000441	8L 16X1,5	2,48 €
EO905B	ΡΣ-000438	10L 22X1,5	2,75 €
	ΡΣ-000448	10L 12X1,5	2,55 €
EO905	ΡΣ-000406	10L 14X1,5	1,39 €
EO905Γ	ΡΣ-000432	10L 16X1,5	2,60 €
EO905A	ΡΣ-000435	10L 18X1,5	2,69 €
EO906Γ	ΡΣ-000444	12L 12X1,5	2,78 €
EO906Δ	ΡΣ-000442	12L 14X1,5	2,78 €
EO906	ΡΣ-000407	12L 16X1,5	1,78 €
EO906A	ΡΣ-000433	12L 18X1,5	3,28 €
EO906B	ΡΣ-000439	12L 22X1,5	2,88 €
EO907	ΡΣ-000408	15L 18X1,5	2,81 €
EO907A	ΡΣ-000434	15L 22X1,5	3,15 €
EO917	ΡΣ-000419	16S 22X1,5	3,16 €
EO908	ΡΣ-000409	18L 22X1,5	5,82 €
EO908	ΡΣ-000443	18L 26X1,5	8,89 €



MALE STUD FITTINGS

ΜΑΣΤΟΙ ΒΑΣΗΣ ΚΟΝΙΚΟ

ΚΩΔΙΚΟΣ	ΔΙΑΜΕΤ.	ΤΙΜΗ
EO844	ΡΣ-001804 6 L-1/8	1,04 €
EO881A	ΡΣ-001824 6 L-1/4	1,41 €
EO882B	ΡΣ-001825 8L-1/8	3,52 €
EO882	ΡΣ-001805 8 L-1/4	1,46 €
EO882A	ΡΣ-001826 8 L 3/8	3,85 €
EO883	ΡΣ-001806 10 L-1/4	1,64 €
EO883A	ΡΣ-001829 10 L-3/8	1,89 €
EO883Γ	ΡΣ-001827 10 L-1/2	4,72 €
EO-850	ΡΣ-001828 10L-1/8	3,61 €
EO885	ΡΣ-001831 12 L-1/4	1,91 €
EO885	ΡΣ-001807 12 L-3/8	1,81 €
EO886	ΡΣ-001832 12 L-1/2	2,69 €
EO887A	ΡΣ-001833 15 L-3/8	5,45 €
EO887	ΡΣ-001808 15 L-1/2	2,68 €
EO888	ΡΣ-001809 18 L-1/2	3,33 €



ΣΥΝΔΕΣΜΟΣ ΠΙΝΑΚΑ ΤΗ 102 01

ΚΩΔΙΚΟΣ	ΔΙΑΜΕΤΡΟΣ	ΤΙΜΗ
EO1350	ΡΣ-003604 6 L	2,79 €
EO1351	ΡΣ-003605 8 L	2,96 €
EO1352	ΡΣ-003606 10 L	3,68 €
EO1353	ΡΣ-003607 12 L	4,42 €
EO1356	ΡΣ-003618 14 S	10,18 €
EO1354	ΡΣ-003608 15 L	6,35 €
EO1356	ΡΣ-003619 16 S	9,90 €
EO1354A	ΡΣ003609 18 L	9,95 €



ΡΑΚΟΡ ΠΙΝΑΚΑ 03 ΚΟΝΤΡΑ ΦΡΕΝΩΝ

ΚΩΔΙΚΟΣ	ΔΙΑΜΕΤΡΟΣ	ΤΙΜΗ
EU1640	ΡΦ-010019 10L-22X1,5	4,60 €
EU1641	ΡΦ-010013 12L-22X1,5	4,60 €
EU1642	ΡΦ-010014 15L- 22X1,5	4,60 €
EU1643	ΡΦ-010015 22X1,5 -22X1,5	4,60 €
EU1644	ΡΦ-010016 16X1,5-12L18X1,5	4,60 €
EU1645	ΡΦ010017 16X1,5 ΒΑΣ.22X1,5	4,60 €
EU1646	ΡΦ-010018 18X1,5 ΒΑΣ.22X1,5	4,60 €



ΣΥΝΔΕΤΙΚΕΣ ΟΥΡΕΣ ΠΛΑΣΤΙΚΗΣ ΣΩΛΗΝΑΣ ΑΕΡΟΣ

ΚΩΔΙΚΟΣ	ΔΙΑΜΕΤΡΟΣ	ΤΙΜΗ
SP8030	6X1	1,65 €
SP8031	8X1	1,65 €
SP8032	10X1	1,70 €
SP8033	12X1.5	1,70 €



ΣΥΣΤΟΛΙΚΕΣ ΟΥΡΕΣ ΠΛΑΣΤΙΚΗΣ ΣΩΛΗΝΑΣ ΑΕΡΟΣ

ΚΩΔΙΚΟΣ	ΔΙΑΜΕΤΡΟΣ	ΤΙΜΗ
SP8035	6X1-8X1	1,60 €
SP8036	8X1-10X1	1,60 €
SP8037	10X1-12X1,5	1,80 €



ΜΑΣΤΟΙ ΑΕΡΟΣ ΙΣΙΑ ΕΔΡΑ

ΚΩΔΙΚΟΣ	ΔΙΑΜΕΤΡΟΣ	ΤΙΜΗ
NL5130	22X1,5-22X1,5	2,20 €
NL5131	26X1,5-26X1,5	2,20 €
NL5132	22X1,5-26X1,5	2,30 €
FA8011	16X1,5-12X1,5	1,60 €



ΠΑΞΙΜΑΔΙΑ - ΚΑΠΕΛΑΚΙΑ

ΚΩΔΙΚΟΣ	ΔΙΑΜ.	ΤΙΜΗ
PB480	ΡΦ020010 ΜΑΚΡΥ 22X1.5	1,36 €
PB481	ΡΦ020011 ΜΑΚΡΥ 26X1.5	1,72 €
R3002	ΡΦ020012 ΚΑΠΕΛΑΚΙ L15	0,46 €
R3003	ΡΦ020013 ΚΑΠΕΛΑΚΙ L18	0,59 €



STUD ELBOW FITTING

ΓΩΝΙΑ ΒΑΣΕΩΣ 94 ΚΩΝΙΚΗ NPT

ΚΩΔΙΚΟΣ	ΔΙΑΜΕΤΡΟΣ	ΤΙΜΗ	
EO978	ΡΣ-002206	10L 14X1,5	3,89 €
EO979	ΡΣ-002207	12L 16X1,5	4,70 €
EO976	ΡΣ-002204	6L-10X1	3,30 €
EO977	ΡΣ-002205	8L-12X1,5	3,56 €
EO948	ΡΣ-002001	4LL- 1/8	3,06 €
EO951	ΡΣ-002002	6 L-1/8	3,30 €
EO952	ΡΣ-002024	6 L-1/4	3,45 €
EO954	ΡΣ-002025	8 L-1/8	3,48 €
EO953	ΡΣ-002005	8 L-1/4	3,48 €
EO955	ΡΣ-002026	8 L-3/8	4,50 €
EO956	ΡΣ-002006	10 L-1/4	3,89 €
EO957	ΡΣ-002029	10 L-3/8	4,57 €
EO957A	ΡΣ-002030	10 L-1/2	5,39 €
EO958	ΡΣ-002007	12 L-3/8	4,70 €
EO979	ΡΣ-002207	12 L-16X1,5	4,82 €
EO959	ΡΣ-002031	12 L-1/4	4,70 €
EO960	ΡΣ-0032	12 L-1/2	5,52 €
EO958	ΡΣ-002033	15 L-3/8	5,79 €
EO961	ΡΣ-002008	15 L-1/2	5,79 €
EO963	ΡΣ-002009	18L-1/2	7,49 €
EO971	ΡΣ-002018	14 S-1/2	8,66 €
EO972	ΡΣ-002019	16 S-1/2	8,05 €



ELBOW FITTINGS

ΓΩΝΙΑΚΟΙ ΣΥΝΔΕΣΜΟΙ ΣΤΑΘΕΡΟΙ

ΚΩΔΙΚΟΣ	ΔΙΑΜΕΤΡΟΣ	ΤΙΜΗ	
EO1136	ΡΣ-003801	4LL	3,38 €
EO1139	ΡΣ-003804	6L	3,40 €
EO1140	ΡΣ-003805	8L	3,72 €
EO1141	ΡΣ-003806	10L	4,03 €
EO1142	ΡΣ-003807	12L	4,69 €
EO1152	ΡΣ-003818	14S	9,24 €
EO1143	ΡΣ-003808	15L	6,36 €
EO1153	ΡΣ-003819	16S	8,57 €
EO1144	ΡΣ-003809	18L	8,42 €



ELBOW FITTINGS ADJUSTABLE

ΓΩΝΙΑ ΑΡΣΕΝ-ΘΗΛ (ΤΡΕΛΟ ΠΑΞ)

ΚΩΔΙΚΟΣ	ΔΙΑΜΕΤΡΟΣ	ΤΙΜΗ	
EO1202	ΡΣ-004204	6 L	3,77 €
EO1203	ΡΣ-004205	8 L	3,96 €
EO1204	ΡΣ-004206	10 L	4,44 €
EO1205	ΡΣ-004207	12 L	5,18 €
EO1215	ΡΣ-004218	14 S	8,59 €
EO1206	ΡΣ-004208	15 L	6,42 €
EO1206	ΡΣ-004219	16 S	8,68 €
EO1207	ΡΣ-004209	18 L	8,71 €
EO1208	ΡΣ-004210	22L	12,44 €
EO1202	ΡΣ-004204	6 L	3,77 €



ELBOW BULKHEAD FITTINGS

ΓΩΝΙΑ ΠΙΝΑΚΑ

ΚΩΔΙΚΟΣ	ΔΙΑΜΕΤΡΟΣ	ΤΙΜΗ	
EO1360	ΡΣ-003704	6 L	5,60 €
EO1361	ΡΣ-003705	8 L	5,81 €
EO1362	ΡΣ-003706	10 L	6,65 €
EO1363	ΡΣ-003707	12 L	7,93 €
EO1365	ΡΣ-003718	14 S	16,67 €
EO1364	ΡΣ-003708	15 L	9,55 €
EO1366	ΡΣ-003719	16 S	13,08 €
EO1364A	ΡΣ-003708	18 L	13,31 €



BANJOS

ΡΑΚΟΡ ΤΙΜΟΝΙΟΥ

ΚΩΔΙΚΟΣ	ΔΙΑΜΕΤΡΟΣ	ΤΙΜΗ	
EO1275	ΡΣ-001404	6L-10X1	8,16 €
EO1276	ΡΣ-001405	8L-12X1,5	8,67 €
EO1277	ΡΣ-001406	10L-14X1,5	9,03 €
EO1278	ΡΣ-001407	12L-16X1,5	11,25 €
EO1279	ΡΣ-001408	15L-18X1,5	13,15 €
EO1280	ΡΣ-001409	18L-22X1,5	20,13 €
EO1281	ΡΣ-001410	22L-26X1,5	26,62 €



TEE FITTINGS ADJUSTABLE

ΤΑΦ ΤΡΕΛΟ ΣΤΗΝ ΑΚΡΗ

ΚΩΔΙΚΟΣ	ΔΙΑΜΕΤΡΟΣ	ΤΙΜΗ	
EO1240	ΡΣ-004604	6 L	5,69 €
EO1241	ΡΣ-004605	8 L	5,89 €
EO1242	ΡΣ-004606	10 L	6,67 €
EO1243	ΡΣ-004607	12 L	7,44 €
EO1253	ΡΣ-004618	14 S	14,14 €
EO1244	ΡΣ-004608	15 L	9,86 €
EO1254	ΡΣ-004619	16 S	14,11 €
EO1245	ΡΣ-004609	18 L	13,28 €
EO1246	ΡΣ-004610	22L	19,88 €



ΣΥΝΔΕΣΜΟΙ ΤΑΦ ΣΤΑΘΕΡΑ

ΚΩΔΙΚΟΣ	ΔΙΑΜΕΤΡΟΣ	ΤΙΜΗ	
EO1158	ΡΣ-003901	4LL	4,16 €
EO1161	ΡΣ-003904	6L	4,46 €
EO1162	ΡΣ-003905	8L	4,87 €
EO1163	ΡΣ-003906	10L	5,60 €
EO1164	ΡΣ-003907	12L	6,48 €
EO1174	ΡΣ-003918	14S	12,65 €
EO1165	ΡΣ-003908	15L	8,60 €
EO1175	ΡΣ-003919	16S	11,70 €
EO1166	ΡΣ-003909	18L	11,56 €



TEE FITTINGS ADJUSTABLE

ΤΑΦ ΤΡΕΛΟ ΣΤΗ ΜΕΣΗ

ΚΩΔΙΚΟΣ	ΔΙΑΜΕΤΡΟΣ	ΤΙΜΗ
EO1221 ΡΣ-005004	6 L	5,53 €
EO1222 ΡΣ-005005	8 L	5,81 €
EO1223 ΡΣ-005006	10 L	6,67 €
EO1224 ΡΣ-005007	12 L	7,05 €
EO1225 ΡΣ-005008	15L	9,46 €
EO1234 ΡΣ-005018	14 S	13,75 €
EO1235 ΡΣ-005019	16 S	12,78 €
EO1226 ΡΣ-005009	18 L	12,64 €
EO1227 ΡΣ-005010	22L	20,03 €



ΤΑΦ ΑΝΑΜΟΝΩΝ

ΚΩΔΙΚΟΣ	ΔΙΑΜΕΤΡΟΣ	ΤΙΜΗ
AN3275 ΡΦ-130001	16X1,5-Av.16X1,5 10L	8,77 €
AN3276 ΡΦ-130002	16X1,5-Av.18X1,5 12L	8,70 €
AN3277 ΡΦ-130003	16X1,5-Av. 11\16 (1/2)	9,00 €
AN3278 ΡΦ-130004	22X1,5-Av.18X1,5 12L	8,90 €
AN3279 ΡΦ-130005	22X1,5-Av.22X1,5	8,60 €
AN3280 ΡΦ-130006	18X1,5-Av.18X1,5	7,70 €
AN3281 ΡΦ-130007	18X1,5-Av. 12L Τρελό	9,20 €
AN3282 ΡΦ-130008	16X1,5-16X1,5 10LAv.	9,70 €
AN3283 ΡΦ-130009	16X1,5-18X1,5 12LAv.	9,70 €
AN3284 ΡΦ-130010	16X1,5-11\16 AN.	11,40 €
AN3285 ΡΦ-130011	22X1,5-18X1,5 12LAv.	10,00 €
AN3286 ΡΦ-130012	22X1,5-22X1,5 AN.	10,00 €
AN3287 ΡΦ-130013	16X1,5-Av-17\32(3/8)	11,40 €



ΤΑΦ ΠΛΑΣΤΙΚΗΣ ΣΩΛΗΝΑΣ ΑΕΡΟΣΠΛΑΣΤΙΚΗΣ

ΚΩΔΙΚΟΣ	ΔΙΑΜΕΤΡΟΣ	ΤΙΜΗ	
PA-011700 ΡΦ-140040	6X1	3,76 €	
PA-011702 ΡΦ-140041	8X1	3,76 €	
PA-011707 ΡΦ-140042	10X1-11X1,5	4,22 €	
	ΡΦ-140043	12X1,5	4,22 €



ΤΑΦ ΟΡΓΑΝΩΝ

EU3300 ΡΦ-150010	1\8	6,46 €
EU3301 ΡΦ-150014	1\4	6,46 €
EU3302 ΡΦ-150011	10X1	6,46 €
EU3303 ΡΦ-150012	12X1,5	7,36 €
EU3304 ΡΦ-150013	14X1,5	7,36 €
EU3305 ΡΦ-150016	16X1,5	8,40 €
EU3306 ΡΦ-150017	18X1,5	8,74 €



CROSS FITTINGS

ΣΤΑΥΡΟΙ TN 101

EO1181 ΡΣ-004004	6 L	13,55 €
EO1184 ΡΣ-004005	8 L	14,86 €
EO1185 ΡΣ-004006	10 L	16,11 €
EO1186 ΡΣ-004007	12 L	17,90 €
EO1187 ΡΣ-004008	15 L	21, €



ΘΗΛΙΣ ΑΕΡΟΣ ΣΩΛ ΠΟΛ & ΧΕΙΡΟΠΡΕΣΑΣ

ΚΩΔΙΚΟΣ	ΣΩΛ	ΤΡΥΠΑ	ΤΙΜΗ	
PA296A PX-002963	8mm	6X1	1,55 €	
PA297A PX-002971	10mm	6X1	1,96 €	
PA297B PX-002972	10mm	8X1	2,14 €	
PA298Z RX-002986	12mm	6X1	2,31 €	
PA298B PX-002982	12mm	8X1	2,18 €	
PA298Γ PX-002983	12mm	10X1	2,60 €	
PA298Δ PX-002984	14mm	6X1	3,30 €	
PA300A PX-003001	14mm	8X1	2,76 €	
PA300B PX-003002	14mm	10X1	2,82 €	
PA300Δ PX-003003	14mm	12X1,5	4,04 €	
	RX-003014	16mm	6X1	6,32 €
PA301B PX-003013	16mm	8X1	4,46 €	
PA301Γ PX-003012	16mm	10X1	4,58 €	
PA300Δ PX-003004	16mm	12X1,5	4,58 €	
	PX-003015	18mm	15X1,5	10,14 €

ΘΗΛΙΣ ΓΙΑ ΣΩΛΗΝΑ ΦΛΕΧ

ΚΩΔΙΚΟΣ	ΣΩΛ	ΤΡΥΠΑ	ΤΙΜΗ
PA296 PX-002960	8	3/16	1,58 €
PA296Γ PX-002966	8	1/4	1,09 €
PA297Γ	10	3/16	1,09 €
PA297 PX-002970	10	1/4	1,46 €
PA298 PX-002980	12	1/4	1,91 €
PA298A PX002981	12	5/16	1,78 €
PA301A PX-002992	14	1/4	2,55 €
PA299A PX-002991	14	5/16	2,05 €
PA300 PX-003000	14	3/8	1,89 €
PA301 PX-003010	16	1/2	4,13 €
PA302 PX-003020	18	1/2	6,13 €
PA302A		5/8	6,94 €

ΘΗΛΙΣ ΓΙΑ ΣΩΛΗΝΑ ΦΛΕΧ ΔΙΠΛΗΣ

ΚΩΔΙΚΟΣ	ΣΩΛ	ΤΡΥΠΑ	ΤΙΜΗ
PA296B PX-002962	8	3/16	2,91 €
PA297Δ PX-002974	10	1/4	5,32 €
PA298E PX-002985	12	5/16	5,78 €
PA302B PX-003022	14	3/8	6,77 €



ΚΟΛΛΗΤΕΣ ΘΗΛΙΣ

ΚΩΔΙΚΟΣ	ΣΩΛ	ΤΡΥΠΑ	ΤΙΜΗ	
ΘK446A	8	5	0,60 €	
	ΡΠ-280008	8	6	0,62 €
ΘK446B	ΡΠ-280010	10	6	0,66 €
ΘK445E	ΔΙΠΛΗ	12	6	2,00 €
ΘK446Γ		12	6	0,94 €
	ΡΠ-280012	12	8	0,90 €
	ΡΠ-280014	14	10	1,02 €
ΘK445Δ	ΔΙΠΛΗ	14	10	7,16 €
ΘK446E	BA-051451	16	12	1,60 €
ΘK446Z		18	12	2,14 €
	ΡΠ-280018	18	15	2,18 €
ΘK445A		20	16	2,64 €
ΘK446		22	18	3,85 €
		26	20	7,25 €



MALE FEMALE STUD ADAPTORS

ΜΟΥΦΑ ΑΓΓΛΙΑΣ 03-04

ΚΩΔΙΚΟΣ		ΑΡΣΕΝΙΚΟ	ΘΗΛΥΚΟ	ΤΙΜΗ
MU3011	PΦ-120001	16x1,5	22x1,5	2,48 €
MU3016	PΦ-120009	22x1.5	VOSS	4,46 €
MU3017	PΦ-120010	16X1,5	22X1,5 VOSS	3,76 €
MU3018	PΦ-120008	16X1,5	16X1,5VOSS	4,46 €
	PΦ-120006	22X1,5	16X1,5VOSS	3,19 €
MU/3012	PΦ-120002	1/4	22X1,5	2,48 €
MU3013	PΦ-120003	3/8	22X1,5	2,48 €
MU3014	PΦ-120004	1/2	22X1,5	2,70 €
MU3015	PΦ-120005	22X1,5	1/2	2,58 €
	PΦ-120012	3/8	18X1,5	3,48 €
MU3010		1/4	16X1,5	2,14 €



ΜΟΥΦΑ ΑΜΕΡΙΚΗΣ

ΚΩΔΙΚΟΣ		ΑΡΣΕΝΙΚΟ	ΘΗΛΥΚΟ	ΤΙΜΗ
MU3025	PΦ-120007	16X1,5	1/4	2,32 €
MU3026	PΦ-120011	A18X1,5	1/4	2,32 €
MU3027	PΦ-110001	22X1,5	1/4	2,32 €
MU3028	PΦ-110002	22X1,5	16X1,5	1,88 €
MU3029	PΦ-110003	22X1,5	3/8	2,08 €
MU3030	PΦ-110007	22X1,5	14X1,5	2,32 €
MU3031	PΦ-110008	22X1,5	18X1,5	2,32 €



ΜΟΥΦΕΣ ΘΗΛΥΚΕΣ

ΚΩΔΙΚΟΣ		ΑΡΣΕΝΙΚΟ	ΘΗΛΥΚΟ	ΤΙΜΗ
	PΣ-301301		12X1,5	1,44 €
	PΣ-301302		14X1,5	1,88 €
	PΣ-301303		16X1,5	1,98 €
MU1677A	PΣ-301305		18X1,5	2,10 €
MU1678	PΣ-301304		22X1,5	2,55 €



ΑΚΡΑ VOLVO SCANIA

ΚΩΔΙΚΟΣ				ΤΙΜΗ
EU1613		ΑΡΣ.17/32	3/8 ΜΑΚΡΥ	4,08 €
EU1612		ΑΡΣ.17/32	3/8 ΚΟΝΤΟ	3,28 €
EU1608		ΘΗΛ.17/32	3/8	2,60 €
EU1618		ΑΡΣ.11/16	3/8 ΜΑΚΡΥ	5,32 €
EU1614		ΑΡΣ.11/16	3/8 ΚΟΝΤΟ	4,60 €
EU1609		ΘΗΛ.11/16	3/8	3,44 €
EU1617		ΑΡΣ.11/16	1/2 ΜΑΚΡΥ	6,04 €
EU1616		ΑΡΣ.11/16	1/2 ΚΟΝΤΟ	4,40 €
EU1610		ΘΗΛ.11/16		3,44 €
EU1619		ΑΡΣ.13/16	1/2 ΜΑΚΡΥ	6,52 €
EU1618		ΑΡΣ.13/16	1/2 ΚΟΝΤΟ	5,10 €
EU1611		ΘΗΛ.13/16	1/2	4,22 €



ΤΑΠΕΣ ΜΕΤΡΙΚΕΣ Α-Θ ALLEN

ΚΩΔΙΚΟΣ		ΔΙΑΜΕΤΡΟΣ	ΤΙΜΗ
	PΣ-007900	10X1	€ 0,62
TA1855B	PΣ-007920	12X1.5-6L	€ 0,68
TA/1855Γ	PΣ-007921	14X1.5-8L	€ 0,70
TA1855A	PΣ-007922	16X1.5-10L	€ 0,80
TA1856	PΣ-007923	18X1.5-12L	€ 1,00
TA1857	PΣ-007924	20X1,5-12S	€ 1,20
TA1858	PΣ-007925	22X1,5-15L	€ 1,20
TA1859	PΣ-007926	24X1,5-16S	€ 1,80
TA/1860A	PΣ-007927	26X1,5-18L	€ 2,00
TA1850	PΣ-007802	1/4	€ 0,61
TA/1851A	PΣ-007803	3/8	€ 0,84
TA1852	PΣ-007804	1/2	€ 1,11
TA1853	PΣ-007805	5/8	€ 1,72
TA/1750	PΣ-007702	12X1.5	€ 2,09
TA1751	PΣ-007703	ALL.14X1.5	€ 2,34
TA/1752	PΣ-007704	ALL.16X1.5	€ 2,68
TA1753	PΣ-007705	ALL.18X1.5	€ 2,68
TA1755	PΣ-007707	ALL.22X1.5	€ 3,48



ΡΑΚΟΡ ΒΙΔΑ ΓΙΑ ΘΗΛΙΑ (ΛΑΔΟΒΙΔΑ)

ΚΩΔΙΚΟΣ		ΔΙΑΜΕΤΡΟΣ	ΤΙΜΗ
DA303A	PX-003031	M6X1	0,51 €
DA303	PX-003030	M 8X1	0,54 €
DA303B	PX-003032	M 8X1,25	0,64 €
DA304	PX-003040	M10X1	0,60 €
DA304A	PX-003041	M10X1,25	0,72 €
DA304B	PX-003042	M10X1,5	0,82 €
DA305A	PX-003043	M12X1	0,82 €
DA305B	PX-003044	M12X1,25	1,13 €
DA305B	PX-003050	M12X1,5	0,75 €
DA306	PX-003060	M14X1,5	0,80 €
DA307	PX-003070	M16X1,5	1,19 €
DA308	PX-003080	M18X1,5	1,28 €
DA308Δ	PX-003084	M20X1,5	1,78 €
DA308A	PX-003081	M22X1,5	1,78 €
DA308B	PX-003082	M26X1,5	4,66 €
DA308Γ	PX-003083	M30X1,5	8,46 €
DA309	PX-003090	1/2X20	1,26 €
	PX-003091	1/4 BSP	0,80 €
	PX-003092	3/8 BSP	1,04 €
	PX-003093	1/2 BSP	1,50 €
	PX-003094	3/4 BSP	3,23 €
	PX-003095	1" BSP	7,47 €
QH310	PX-003100	8 X 1	1,59 €
QH311	PX-003110	10 X 1	1,84 €
QH312	PX-003120	12 X 1,5	1,93 €
QH313	PX-003130	14 X 1,5	2,42 €
QH314	PX-003140	16 X 1,5	3,08 €
QH315	PX-003150	18 X 1,5	3,19 €



ΑΡΣΕΝΙΚΑ ΚΟΜΦΛΕΡ ουρά πιέσεως

ΚΩΔΙΚΟΣ	ΔΙΑΣΤΑΣΗ	ΤΙΜΗ
H272	16X1,5 -1/2	2,38 €
KO286	ΡΦ-010003 22X1,5-1/2 ΙΣΙΑ	4,04 €
	ΡΦ-010028 22X1,5-1/2 15L	4,86 €
	ΡΦ-010008 22X1,5-1/2 16L	4,04 €
KO286A	ΡΦ-010009 22X1,5-5/8 ΙΣΙΑ	4,80 €
KO289	ΡΦ-010028 26X1,5-1/2 ΙΣΙΑ	4,86 €
KO293	ΡΦ-010007 26X1,5-5/8 ΙΣΙΑ	5,46 €



ΘΗΛΥΚΑ ΚΟΜΦΛΕΡ

ΚΩΔΙΚΟΣ	ΔΙΑΣΤΑΣΗ	ΤΙΜΗ
H284	ΡΠ-161610 18X1,5 -3/8	2,68 €
H284Γ	ΡΠ-161813 18X1,5 -1/2	2,68 €
KO287B	22X1,5 -1/2	1,60 €
HN-112258	22X1,5 -5/8	1,53 €
HN-112612	26X1,5 -1/2	2,20 €
HN-112658	26X1,5 -5/8	2,20 €
HN-111608	16X1,5-8 mm	1,60 €
HN-111606	16x1,5-6 mm	1,60 €
HN-111610	16x1,5-10mm	1,60 €



ΘΗΛΥΚΑ Β.Σ.Ρ

ΚΩΔΙΚΟΣ	ΔΙΑΣΤΑΣΗ	ΤΙΜΗ
H273	PX-002730 1\8 - 1\4	1,87 €
H274	HN-002740 1\4 - 1\4	1,28 €
H276	PX-002760 3\8 - 3\8	1,45 €
H277	HN-081212 1\2 - 1\2	1,45 €
H275	3/8-5/16-1/4	1,32 €



ΘΗΛΥΚΑ ΜΕΤΡΙΚΑ

ΚΩΔΙΚΟΣ	ΔΙΑΣΤΑΣΗ	ΤΙΜΗ
H280	PX-002800 10X1,5 - 1/4	1,20 €
H281	PX-002810 12X1,5 - 1/4	1,20 €
H282	PX-002820 14X1,5 - 5/16	1,36 €
H283	PX-002830 16X1,5 - 3/8	1,50 €
H284	ΡΦ-020001 18X1,5 - 3/8	1,47 €
H284Γ	ΡΦ-020002 18X1,5 -1/2	1,59 €
	ΡΦ-020003 22X1,5 - 1/2	1,68 €
	ΡΦ-020006 22X1,5 - 5/8	2,20 €

ΡΑΚΟΡ ΑΜΠΡΑΓΙΑΣ ACTROS

ΚΩΔΙΚΟΣ	ΒΙΣΜΑ	ΤΙΜΗ
F5117	αρσ, 1/4	4,80 €
F5117A	ουρά 1/4	3,20 €



ΑΡΣΕΝΙΚΑ Ν.Ρ.Τ

ΚΩΔΙΚΟΣ	ΔΙΑΣΤΑΣΗ	ΤΙΜΗ
H259	1\8 - 1\4	1,76 €
H260	1\4 - 1\4	1,60 €
H260A	1\4 - 5\16	1,60 €
H261	PX-002610 1\4 - 3\8	1,81 €
H262	PX-002620 3\8 - 3\8	1,97 €
	PX-002621 3\8 - 1\2	2,15 €
H263	PX-002630 1\2 - 1\2	1,88 €
H264	PX-002640 3\4 -3\4	3,92 €
H260B	PX-002612 1\4 -1\2	1,97 €
H264A	PX-002641 1" - 3/4	4,53 €



ΑΡΣ. ΜΕΤΡΙΚΑ

ΚΩΔΙΚΟΣ	ΔΙΑΣΤΑΣΗ	ΤΙΜΗ
H268	12x1,5-1/4	2,18 €
H269	14x1,5-5/16	2,18 €
H270	ΡΦ-010027 16x1,5-3/8	2,18 €
H271	18x1,5-3/8	2,18 €
H272	ΡΦ-010000 16X1,5-1/2"	2,18 €



ΒΑΛΒΙΔΑ ΚΑΖΑΝΙΟΥ

ΚΩΔΙΚΟΣ	ΔΙΑΣΤΑΣΗ	ΤΙΜΗ
0762649-00	22X1,5	€ 3,20



ΜΑΣΤΟΙ ΑΝΑΜΟΝΩΝ

ΚΩΔΙΚΟΣ	ΔΙΑΣΤΑΣΗ	ΤΙΜΗ
ΡΦ-130021	6L-1\4	1,54 €
ΡΦ-130022	6L-16X1,5	1,94 €
ΡΦ-130023	6L-22X1,5	2,20 €



ΑΝΑΜΟΝΕΣ ΘΗΛΥΚΟ ΣΠΕΙΡΩΜΑ

ΚΩΔΙΚΟΣ	ΔΙΑΣΤΑΣΗ	ΤΙΜΗ
076354-10	12X1,5	3,74 €
076354-20	14X1,5	4,29 €
076354-30	16X1,5	4,84 €
076354-40	18X1,5	5,39 €
076354-00	22X1,5	6,07 €
RL3506AC	1/4"	3,50 €
RL3506AD	3/8"	3,50 €
076354-10	12X1,5	3,74 €



ΑΥΤΟΜΑΤΟΙ ΣΥΝΔΕΣΜΟΙ ΠΛΑΣΤΙΚΟΙ

ΚΩΔΙΚΟΣ	ΔΙΑΜΕΤΡΟΣ	ΤΙΜΗ	
2400	ΠΛ-260404	4	0,64 €
	ΠΛ-260505	5	0,67 €
2401	ΠΛ-260606	6	0,67 €
2402	ΠΛ-260808	8	0,76 €
2406		9	4,20 €
2403	ΠΛ-261010	10	0,91 €
2407		11	4,40 €
2404	ΠΛ-261212	12	1,03 €
	ΠΛ-261414	14	3,96 €
2405	ΠΛ-261616	16	3,96 €
2420	ΠΛ-260604	6.-.4	0,78 €
2421	ΠΛ-260806	8.-.6	0,88 €
2422	ΠΛ-261008	10.-.8	0,90 €
2423	ΠΛ-261210	12.-.10	1,06 €
2424		16.-.12	1,40 €



ΑΥΤΟΜΑΤΕΣ ΓΩΝΙΕΣ ΠΛΑΣΤΙΚΕΣ

ΚΩΔΙΚΟΣ	ΔΙΑΜΕΤΡΟΣ	ΤΙΜΗ	
2400B	ΠΛ-280400	4	0,66 €
	ΠΛ-280505	5	0,69 €
2401	ΠΛ-280600	6	0,69 €
2402B	ΠΛ-280800	8	0,77 €
2403B	ΠΛ-281000	10	0,94 €
2404B	ΠΛ-281200	12	1,10 €
	ΠΛ-281400	14	4,10 €
2405B	ΠΛ-281600	16	4,10 €



ΑΥΤΟΜΑΤΑ ΤΑΦ ΠΛΑΣΤΙΚΑ

ΚΩΔΙΚΟΣ	ΔΙΑΜΕΤΡΟΣ	ΤΙΜΗ	
2400A	ΠΛ-290400	4	0,88 €
	ΠΛ-290500	5	0,84 €
2401A	ΠΛ-290600	6	0,84 €
2402A	ΠΛ-290800	8	0,84 €
2403A	ΠΛ-291000	10	1,06 €
2404A	ΠΛ-291200	12	1,28 €
	ΠΛ-291400	14	5,80 €
2405A	ΠΛ-291600	16	5,80 €



ΡΟΔΕΛΕΣ ΑΛΟΥΜΙΝΙΟΥ

ΚΩΔΙΚΟΣ	ΔΙΑΜΕΤΡΟΣ	ΤΙΜΗ	
	22806092	6/10X1	0,03 €
	22808092	8/13X1	0,04 €
	22810092	10/15X1	0,06 €
	22812092	12/17X1	0,06 €
	22814092	14/20X1	0,07 €
	22816092	16/22X1	0,08 €
	22818092	18/24X1,5	0,08 €
	22822092	22/18X1,5	0,09 €



LOCK NUTS

ΠΕΡΙΚΟΧΛΙΑ ΚΟΝΤΡΑ

ΚΩΔΙΚΟΣ	ΔΙΑΜΕΤΡΟΣ	ΤΙΜΗ	
NR112-01	ΡΣ-140012	12X1,5	0,62 €
NR112-02	ΡΣ-140014	14X1,5	0,68 €
NR112-03	ΡΣ-140016	16X1,5	0,53 €
NR112-04	ΡΣ-140018	18X1,5	0,48 €
NR112-05		20X1,5	0,92 €
NR112-06	ΡΣ-140022	22X1,5	1,09 €



ΡΟΔΕΛΕΣ ΟΡΕΙΧΑΛΚΟΥ ΜΕ ORING

ΚΩΔΙΚΟΣ	ΔΙΑΜΕΤΡΟΣ	ΤΙΜΗ	ΚΩΔΙΚΟΣ
	ΡΦ-100001	12X1,5	0,47 €
	ΡΦ-100002	14X1,5	0,47 €
	ΡΦ-100003	16X1,5	0,47 €
	ΡΦ-100004	18X1,5	0,52 €
	ΡΦ-100005	22X1,5	0,52 €



ΜΕΤ/ΚΕΣ ΡΟΔΕΛΕΣ ΜΕ ΕΛΑΣΤ ΔΑΚΤ

ΚΩΔΙΚΟΣ	Φ ΕΣΩΤ.	ΠΑΧΟΣ	ΤΙΜΗ	
R4470	M5	1mm		
R4471	M6	1mm		
R4472	EE110008	M8	1mm	0,24 €
R4473	EE-110010	M10	1,5mm	0,24 €
R4474	EE-110012	M12	1,5mm	0,25 €
R4475	EE-110014	M14	1,5mm	0,27 €
R4476	EE-110016	M16	1,5mm	0,33 €
R4477	EE-110018	M18	1,5mm	0,35 €
R4478	EE-110020	M20	1,5mm	0,37 €
R4479	EE-110022	M22	2mm	0,40 €
R4480	EE-110024	M24	2mm	0,42 €
	EE-110026	0,24 €	2mm	0,52 €
R4481		M27	2mm	
R4482		M33		



ΡΟΔΕΛΕΣ ΧΑΛΚΟΥ

ΚΩΔΙΚΟΣ	ΔΙΑΜΕΤΡΟΣ	ΤΙΜΗ	
	R4441	Φ6 mmX1	0,09 €
	R4442	Φ8 mmX1,5	0,11 €
	R4443	Φ10 mm	0,11 €
	R4444	Φ12 mm	0,12 €
	R4446	Φ14 mm	0,13 €
	R4447	Φ16 mm	0,14 €
	R4449	Φ18 mm	0,16 €
	R4450	Φ20 mm	0,22 €
	R4452	Φ22 mm	0,27 €
	R4453	Φ24 mm	0,40 €
	R4454	Φ26 mm	0,40 €



ΣΥΣΤΟΛΙΚΟΣ ΑΥΤΟΜΑΤΟΣ

ΚΩΔΙΚΟΣ	ΣΩΛΗΝΑ	ΒΑΣΗ	ΤΙΜΗ
MA-260604	6mm	4	2,84 €
MA-260806	8mm	6	3,19 €
MA-261008	10mm	8	3,48 €
MA-260908	9mm	8	8,83 €
MA-261211	12mm	11	9,35 €
AS10-12	10mm	12	4,50 €
AS12-14	12mm	14	10,50 €



ΜΑΣΤΟΙ ΑΥΤΟΜΑΤΟΙ ΒΑΣΗΣ ΚΩΝΙΚΟΙ

2837	MA-110418	4mm	1/8	1,16 €
2840	MA-110414	4mm	1/4	1,28 €
2838	MA-110618	6mm	1/8	1,16 €
2841	MA110614	6mm	1/4	1,29 €
2839	MA-110818	8mm	1/8	1,29 €
2842	MA-110814	8mm	1/4	1,29 €
2845	MA-110838	8mm	3/8	1,96 €
2843	MA-111014	10mm	1/4	1,89 €
2846	MA-111038	10mm	3/8	1,96 €
2844	MA-111214	12mm	1/4	2,85 €
2847	MA-111238	12mm	3/8	2,85 €
2850	MA-111212	12mm	1/2	2,93 €
	MA-111438	14mm	3/8	4,04 €
	MA-111412	14mm	1/2	4,55 €
	PN-111818	1/8	1/8	1,98 €
	PN-111418	1/4	1/8	1,65 €
	PN111414	1/4	1/4	1,79 €
	PN113814	3/8	1/4	2,60 €
	PN113838	3/8	3/8	2,74 €
	PN111238	1/2	3/8	3,55 €
	PN111212	1/2	1/2	3,73 €

ΜΕΤΡΙΚΟ ΣΠΕΙΡΩΜΑ

ΚΩΔΙΚΟΣ	ΣΩΛΗΝΑ	ΒΑΣΗ	ΤΙΜΗ
MA-126125	6MM	12X1,5	2,33 €
	8MM	12X1,5	2,46 €



ΤΑΦ ΥΨΙΛΟΝ

ΚΩΔΙΚΟΣ	ΣΩΛΗΝΑ	ΒΑΣΗ	ΤΙΜΗ
MA-370404		4MM	5,15 €
MA-370606		6MM	5,21 €
MA-370808		8MM	6,15 €
PN-371414		1/4	6,64 €



ΣΥΝΔΕΣΜΟΣ ΑΥΤΟΜΑΤΟΣ

ΚΩΔΙΚΟΣ	ΣΩΛΗΝΑ	ΤΙΜΗ	
MA-260300	3	4,66 €	
2800	MA-260400	4	2,56 €
2801	MA-260500	5	3,29 €
2802	MA-260600	6	2,28 €
2803	MA-260800	8	2,66 €
	MA-260909	9	6,37 €
2804	MA-261000	10	2,90 €
	MA-261111	11	6,81 €
2805	MA-261200	12	4,26 €
2806	MA-261400	14	5,91 €
	PN-261818	1/8	4,96 €
	PN-261414	1/4	3,39 €
	PN-263838	3/8	3,91 €
	PN-261313	1/2	5,46 €
	MA-261515	15	9,13 €



ΡΑΚΟΡ ΑΡΣΕΝΙΚΟ ΒΙΣΜΑ

ΚΩΔΙΚΟΣ	ΒΙΣΜ-ΒΑΣΗ	ΤΙΜΗ	
2870	MA-3804M5	4 - M5	0,66 €
2871	MA-380418	4 - 1/8"	0,74 €
	MA3806M5	6 - M5	0,74 €
2872	MA-380618	6 - 1/8"	0,78 €
2874	MA-380614	6 - 1/4"	0,93 €
2873	MA-380818	8 - 1/8"	0,78 €
2875	MA-380614	8 - 1/4"	0,93 €
2876	MA-381014	10 - 1/4"	1,01 €
2877		10 - 3/8"	1,42 €
2872	MA-381238	12 - 3/8"	1,42 €
	PN-381418	1/4"-1/8	1,36 €
	PN-381414	1/4"-1/4	1,86 €
	PN-383838	3/8"-3/8	1,94 €
	PN-381238	1/2"-1/2	2,86 €
	PN-381212		3,10 €



ΣΥΝΔΕΣΜΟΙ ΚΟΝΤΡΑ

ΚΩΔΙΚΟΣ	ΣΩΛΗΝΑ	ΚΟΝΤΡΑ	ΤΙΜΗ
MA-270404	4	12X1	3,80 €
MA-270606	6	14X1	4,01 €
MA-270808	8	16X1	4,40 €
MA-271010	10	18X1	5,70 €
MA-271212	12	20X1	6,90 €



TEE PUSH IN CONNECTORS

ΤΑΦ ΑΥΤΟΜΑΤΟ

ΚΩΔΙΚΟΣ	ΣΩΛ	ΤΙΜΗ	
2804A	MA-290303	3	5,59 €
2802A	MA-290404	4	3,15 €
2803A	MA-290606	6	3,31 €
2804A	MA-290808	8	3,85 €
2805A	MA-291010	10	5,10 €
2806A	MA-291212	12	6,64 €
	MA-291414	14	9,68 €
	MA-290505	5	3,97 €
	PN-291818	1\8	5,95 €
	PN-291414	1\4	4,24 €
	PN-293838	3\8	6,48 €



ELBOW FITTINGS

ΓΩΝΙΑ ΑΥΤΟΜΑΤΗ

ΚΩΔΙΚΟΣ	ΣΩΛΗΝΑ	ΒΑΣΗ	ΤΙΜΗ
2800B	MA-280303	3MM	4,14 €
2802B	MA-280303	4MM	2,54 €
2803B	MA-280606	6MM	2,54 €
2804B	MA-280808	8MM	2,83 €
2805B	MA-281010	10MM	3,92 €
2806B	MA-28112	12MM	4,64 €
	MA-281414	14MM	7,18 €
	PN-281818	1\8	4,68 €
	PN-281414	1\4	3,41 €
	PN-283838	3\8	5,25 €
	PN-281313	1\2	6,53 €



ΓΩΝΙΕΣ ΠΕΡ/ΚΕΣ ΒΑΣΗΣ ΜΕΤΡΙΚΕΣ

ΚΩΔΙΚΟΣ	ΣΩΛΗΝΑ	ΒΙΣΜΑ	ΤΙΜΗ	
2822	MA-150418	4	1\8	2,20 €
2825	MA150414	4	1\4	2,40 €
2823	MA-150618	6	1\8	2,20 €
2826	MA150614	6	1\4	2,40 €
2824	MA-150818	8	1\8	2,62 €
2827	MA150814	8	1\4	2,76 €
2829	MA-150838	8	3\8	3,17 €
2828	MA-150014	10	1\4	3,91 €
2846	MA150038	10	3\8	4,18 €
2831	MA-150238	12	3\8	4,94 €
	MA-151438	14	3\8	7,16 €
	MA-151412	14	1\2	7,84 €
	PN-151818	1\8		3,65 €
	PN-151418	1\4		3,17 €
	PN-151414	1\4		3,43 €
	PN153814	3\8		4,98 €
	PN153838	3\8		5,32 €
	PPN151238	3\8		6,29 €
	PN-151212	1\2		6,92 €
	MA-160615	6-12X1,5		3,45 €



STUD PUSH IN FITTINGS

ΤΑΦ ΑΡΣ ΜΕΣΗ ΤΡΕΛΟ

ΚΩΔΙΚΟΣ	ΣΩΛΗΝΑ	ΒΑΣΗ	ΤΙΜΗ
MA-200418	4	1\8	3,35 €
MA-200618	6	1\8	3,35 €
MA-200614	6	1\4	3,57 €
MA-200818	8	1\8	3,78 €
MA-200814	8	1\4	4,00 €
MA-201014	10	1\4	5,56 €
MA-201238	12	3\8	7,60 €



ΤΑΦ ΑΚΡΗ ΑΡΣ ΤΡΕΛΟ

ΚΩΔΙΚΟΣ	ΣΩΛΗΝΑ	ΒΑΣΗ	ΤΙΜΗ
MA-230418	4	1\8	3,64 €
MA-230618	6	1\8	3,41 €
MA-230614	6	1\4	3,64 €
MA-230818	8	1\8	3,85 €
MA-230814	8	1\4	4,08 €
MA-231014	10	1\4	5,68 €
MA-231238	12	3\8	7,60 €



ΚΟΡ ΣΥΣΤΟΛΙΚΟ

ΚΩΔΙΚΟΣ	ΣΩΛΗΝΑ	ΒΑΣΗ	ΤΙΜΗ
MA-250304	3	4	3,23 €
MA-250406	4	6	1,59 €
MA-250408	4	8	1,59 €
MA-250608	6	8	1,61 €
MA-250610	6	10	1,61 €
MA-250612	6	12	1,69 €
MA-250810	8	10	1,73 €
MA-250812	8	12	1,75 €
MA-251012	10	12	1,80 €
MA-250604	6	4	1,94 €
MA250806	8	6	1,94 €
PN-251438	1\4	3\8	5,46 €
PN-253812		1\2	6,16 €

ΣΤΑΥΡΟΙ ΑΥΤΟΜΑΤΟΙ

ΚΩΔΙΚΟΣ	ΣΩΛΗΝΑ	ΤΙΜΗ
2855	Φ4	8,10 €
2856	Φ6	8,10 €
2857	Φ8	8,90 €
2858	Φ10	10,90 €

ΣΥΣΤΟΛΙΚΑ ΚΟΥΜΠΟΤΑ

ΚΩΔΙΚΟΣ	ΣΩΛΗΝΑ	ΤΙΜΗ
2860	4-L6	1,70 €
2861	4-L8	1,70 €
2862	6L-8	1,70 €
2863	6-L10	1,70 €
2864	8-L10	1,85 €
2865	8-12L	1,85 €
2866	10-L12	1,95 €



ΣΩΛΗΝΑ ΑΕΡΟΣ ΛΑΔΙΟΥ 1 ΛΙΝΟ R6

ΚΩΔΙΚΟΣ	ΕΣ.ΔΙΑΜ	BAR	ΤΙΜΗ/m	
HL770A	ΣΠ-060005	3\16	34	4,20 €
HL770	ΣΠ-060006	1\4	28	3,97 €
HL771	ΣΠ-060008	5\16	28	4,14 €
HL772	ΣΠ-060010	3\8	28	4,60 €
HL773	ΣΠ-060013	1\2	28	5,27 €
HL774	ΣΠ-060016	5\8	24	7,50 €
HL775	ΣΠ-060019	3\4	21	7,84 €



ΣΩΛΗΝΑ ΟΞΥΓΟΝΟΥ-ΑΣΕΤΥΛΙΝΗΣΔΙΠΛΟΣ

ΚΩΔΙΚΟΣ	ΕΣ.ΔΙΑΜ	BAR	ΤΙΜΗ/m	ΤΙΜΗ/
VUD8X15	HO-100516	5/16	20	3,20 €



ΣΩΛΗΝΑ ΜΕΤΑΛΛΙΚΗ ΕΥΚΑΜΠΤΗ ΦΡΕΝΟΥ

ΚΩΔΙΚΟΣ	ΔΙΑΜΕΤΡΟΣ	ΤΙΜΗ/m	
BR746	HO-120316	3/16"-5 mm	2,56 €
BR748	HO-120006	6X0,75mm	2,85 €
BR750	HO-120008	8X0,75 mm	3,24 €
BR751	HO-120010	10x1 mm	4,96 €



ΣΩΛΗΝΑ ΕΛΑΣΤΙΚΗ ΜΕ ΣΥΡΜΑΤΙΝΗ ΕΠΕΝΔΥΣΗ ΥΨΗΛΗΣ ΠΙΕΣΕΩΣ

ΚΩΔΙΚΟΣ	ΔΙΑΜΕΤΡΟΣ	ΤΙΜΗ/m	
HL509A	ΣΠ-010005	3\16	4,20 €
HL510	ΣΠ-010006	1\4	3,97 €
HL511	ΣΠ-010008	5\16	4,14 €
HL512	ΣΠ-0100010	3\8	4,60 €
HL513	ΣΠ-0100013	1\2	5,24 €
HL514	ΣΠ-0100016	5\8	6,47 €
HL515	ΣΠ-0100019	3\4	7,77 €



ΣΩΛΗΝΑ ΚΑΜΠΙΝΑΣ - ΓΡΑΣΣΑΔΟΡΟΥ R7

ΚΩΔΙΚΟΣ	ΕΣ.ΔΙΑΜ	BAR	ΤΙΜΗ/m
ΣΠ-070003	4MM	200	3,30 €
ΣΠ-000004	4MM GR7	400	6,51 €
ΣΠ-070005	3/16	200	3,30 €



ΣΩΛΗΝΑΣ ΜΕΓΑΛΗΣ ΘΕΡΜΟΚΡΑΣΙΑΣ 150

ΚΩΔΙΚΟΣ	ΕΣ. ΔΙΑΜ	BAR	ΤΙΜΗ/m	
EQ2063	ΣΠ-130113	1\2	160	14,91 €
ΣΠ-130116	5\8	130	17,12 €	
EQ2065	ΣΠ-130119	3\4	105	19,64 €



ΣΩΛΗΝΑ ΑΕΡΟΣ ΠΟΛΥΜΑΜΙΔΙΟΥ

ΚΩΔΙΚΟΣ	BAR	ΣΩΛΗΝΑ	ΤΙΜΗ	
PD602	ΣΒ-110402	50	4X1 mm	0,42 €
PD602A	ΣΒ-110503		5X1mm	0,83 €
PD603	ΣΒ110604	30	6X1mm	0,60 €
PD604	ΣΒ-110806	21	8X1 mm	0,82 €
PD614A	ΣΒ-110906		9X1,5 mm	2,20 €
	ΣΒ-111077		10X1,5 mm	2,62 €
PD605	ΣΒ-111007		10X,25 mm	2,40 €
PD606	ΣΒ-111008	17	10X1 mm	1,48 €
PD607	ΣΒ-111109		11X1,5 mm	2,94 €
PD608	ΣΒ-111209	17	12X1,5 mm	2,44 €
PD608B	ΣΒ-111410		14X2mm	4,88 €
PD609	ΣΒ-111512		15X1,5mm	3,71 €
PD615	ΣΒ-112013		1\2	3,32 €
PD613	ΣΒ-112006		1\4	1,10 €
PD611	ΣΒ-112003		1\8	1,48 €
PD614	ΣΒ-112010		3\8	2,00 €
PD612	ΣΒ-11205		3\16	0,95 €
	PT-011115		5\8	4,02 €
	ΣΒ-111612		16X2mm	6,10 €
	ΣΒ-110705		7X1mm	1,14 €
	ΣΒ-111814		18X2mm	7,42 €



ΣΩΛΗΝΕΣ ΑΕΡΟΣ ΜΕ ΛΙΝΑ 20 ΑΤΜ ΑΕΡΟΣ/ΠΙΕΣΤΩΝ

ΚΩΔΙΚΟ	ΕΣ. ΔΙΑΣΤ	ΕΣ. ΔΙΑΣΤ	ΤΙΜΗ
ΣΒ-142106	6	13	1,42 €
ΣΒ-142106	8	16	1,84 €
ΣΒ-142106	10	19	1,89 €
ΣΒ-142106	13	23	2,67 €
ΣΒ-142106	16	26	4,33 €
ΣΒ-142106	19	30	3,41 €
ΣΒ-142106	25	37	3,95 €



ΔΕΜΑΤΙΚΑ

ΚΩΔΙΚΟΣ	ΔΙΑΜΕΤΡΟΣ	ΤΙΜΗ	
CL3240	DM100	100X2,5	1,70 €
CL3241	DM140	140X3,5	1,80 €
CL3242	DM200	160X4,5	3,90 €
CL3243	DM250	200X4,8	4,20 €
CL/3244	DM300	280X4,8	4,98 €
CL/3245	DM368	360X4,8	7,40 €
	DM370	370X7,80	9,00 €



ΧΑΛΚΟΣΩΛΗΝΕΣ

ΚΩΔΙΚΟΣ	ΔΙΑΜ.
XA641	3/16"
XA642	1/4"
XA643	5/16"

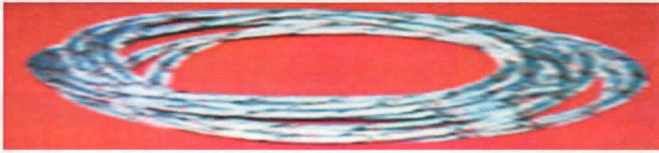

ΣΩΛΗΝΕΣ FLEX ΠΕΤΡΕΛΑΙΟΥ ΛΑΔΙΟΥ ΒΑΡ 15

ΚΩΔΙΚΟΣ	ΕΣ. ΔΙΑΣΤΑΣΗ	ΕΞ. ΔΙΑΣΤΑΣΗ	ΤΙΜΗ
ΣΒ-110004	4,5	9,5	3,15 €
ΣΒ-110005	5,5	10,5	3,41 €
ΣΒ-110007	7,5	12,5	3,94 €
ΣΒ-110009	9	15	4,31 €
ΣΒ-110011	11	17,5	7,46 €



ΣΤΗΡΙΓΜΑΤΑ ΣΙΔΗΡΟΣΩΛΗΝΩΝ ΜΟΝΑ

ΚΩΔΙΚΟΣ	ΔΙΑΜΕΤΡΟΣ	ΤΙΜΗ
1882A ΣΒ-310006	6	1,38 €
1882 ΣΒ-310008	8	1,38 €
1883 ΣΒ-310010	10	1,38 €
1884 ΣΒ-310012	12	1,38 €
1885 ΣΒ-310014	14	1,42 €
1886 ΣΒ-310015	15	1,42 €
1987 ΣΒ-310016	16	1,42 €
1888 ΣΒ-310018	18	1,42 €
1889 ΣΒ-310020	20	1,58 €
1890 ΣΒ-310022	22	1,58 €
1891 ΣΒ-310025	25	1,58 €
1892 ΣΒ-310028	28	1,80 €
1893 ΣΒ-310030	30	1,80 €
1894 ΣΒ-310035	35	2,31 €
1895 ΣΒ-310038	38	2,31 €
1896 ΣΒ-310042	42	2,31 €
1896A	16 ENIS	3,98 €
1897	18 ENIS	4,96 €
1897A	20 ENIS	4,88 €
1897B	22 ENIS	4,88 €
1898	25 ENIS	5,40 €
1899	30 ENIS	5,94 €
1900	35 ENIS	6,64 €
1900A	38 ENIS	6,64 €
1901	42 ENIS	6,64 €

ΚΟΛΙΕΔΕΣ SUPER NORMA

ΚΩΔΙΚΟΣ	ΔΙΑΜΕΤΡΟΣ	ΤΙΜΗ
CL-011719	17-19 mm	1,00 €
CL-011921	19-21 mm	1,05 €
CL-012123	21-23mm	1,10 €



ΣΩΛΗΝΕΣ ΒΕΝΖΙΝΗΣΙΜΕ ΕΣΩΤΕΡΙΚΑ ΛΙΝΑ ΒΑΡ 10

ΚΩΔΙΚΟΣ	ΕΣ. ΔΙΑΣΤΑΣΗ	ΕΞ. ΔΙΑΣΤΑΣΗ	ΤΙΜΗ
ΣΒ-220003	3	7	3,95 €
ΣΒ-220004	4,5	9,5	3,76 €
ΣΒ-220005	5,5	10,5	3,85 €
ΣΒ-220006	7	12	5,06 €
ΣΒ-220008	7,5	12,5	5,06 €
ΣΒ-220010	9	15	6,16 €



ΣΩΛΗΝΕΣ ΑΕΡΟΦΡΕΝΩΝ DIN 74310

ΚΩΔΙΚΟΣ	ΔΙΑΜΕΤΡΟΣ	ΤΙΜΗ
BR753	11X18	4,50 €
BR754	13X25	5,50 €



ΣΤΗΡΙΓΜΑΤΑ ΣΙΔΗΡΟΣΩΛΗΝΩΝ ΑΛΟΥΜΙΝΙΟΥ

ΚΩΔΙΚΟΣ	ΔΙΑΜΕΤΡΟΣ	ΤΙΜΗ
1887AL	16	7,06 €
1888AL ΣΒ-310118	18	6,57 €
1889AL ΣΒ-310120	20	6,40 €
1890AL	22	8,78 €
18891AL ΣΒ-310125	25	6,40 €
18892AL	28	8,78 €
1893AL ΣΒ-310130	30	6,40 €
	ΣΒ-310131 30ΜΕΓ	7,60 €
1894AL ΣΒ-310135	35	7,30 €
1895AL ΣΒ-310138	38	7,30 €
1896AL ΣΒ-310142	42	7,30 €



ΣΤΗΡΙΓΜΑΤΑ ΣΙΔΗΡΟΣΩΛΗΝΩΝ ΔΙΠΛΑ

ΚΩΔΙΚΟΣ	ΔΙΑΜΕΤΡΟΣ	ΤΙΜΗ
	ΣΒ-310206	6 1,56 €
	ΣΒ-310208	8 1,56 €
1902	ΣΒ-310210	10 1,56 €
1903	ΣΒ-310212	12 1,56 €
1904	ΣΒ-310214	14 2,03 €
1905	ΣΒ-310215	15 2,03 €
1906	ΣΒ-310216	16 2,03 €
1907	ΣΒ-310218	18 2,03 €
1908	ΣΒ-310220	20 2,20 €
1909	ΣΒ-310222	22 2,20 €
1910	ΣΒ-310225	25 2,20 €
	ΣΒ-310228	28 2,52 €